

 航太 Aviation
  軍規 Mil Spec
  汽車 Automobile
  能源 Energy
  船舶 Boats
  軌道 Rails
  醫療 Medical

APEX CONNECTORS

Innovative Research
 Diversified Development
 Technical Production
 Quality Service



PLT Trademark Quality Assurance



Apex connector
專業製造廠

錫鋼精密科技

APEX PRECISION TECHNOLOGY

Since 1978

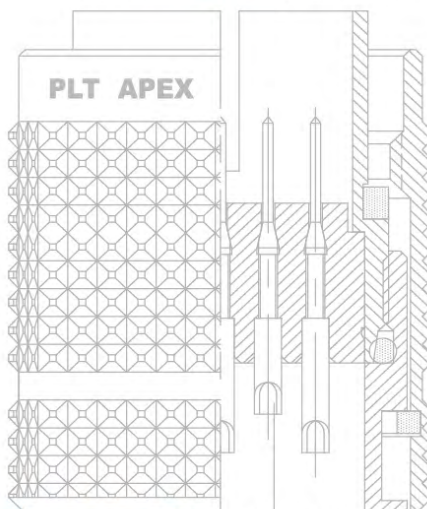

防水防爆 / 電子電機工業連接器
Waterproof and Explosion-proof
Electronic & Electrical Industrial Connectors

APEX Enterprise and Nature Coexistence

Coexistence of human and nature is the highest enterprise principle to APEX. All APEX's staff and operation must be based on the premise of preserving natural environment and protecting the earth.

- Manufacturing the low-pollution products
- Manufacturing without polluting the environment
- Recycle and reuse
- Contribution to protecting the earth
- Development of environmental protection

1.The product information in this catalog is for reference only.

Please request the engineering drawing for the most current and accurate design information.

2.In order to make Improvements In the products,we reserve the right to make changes, updates and corrections to the information provided in this catalog at any time.

Subject to change without notice. Thank you for your understanding.



APEX 企業與自然共存

APEX 應該視(人類和地球自然環境共存)為企業最高指導的原則，所有的APEX職員和企業的全部運作，都要以維護自然環境、保護地球為前提。

- 製造低污染的產品
- 製造處理不汙染環境
- 所有的廢棄物回收再利用
- 為保護地球環境，貢獻一份心力
- 持續環境保護發展的工作

1.本目錄記載數據僅供參考，詳細內容請參考式樣書或圖面。

2.本目錄記載內容為了改進產品如有變更，恕不另行通知敬請見諒。

APEX企業は自然と共存します

APEXはずっとく人類と地球の共存する環境を企業最高指導の原則とし、全てのAPEX社員及び企業の活動は全て地球環境の保護、維持を前提としております。

- 汚染の少ない製品作り
- 製造プロセスでは環境汚染を下げる
- すべての廃棄物は回収または再利用する
- 地球環境保護のため、気力を持って貢献する
- 環盡保護発展の仕事を持続する

1.本カタログ記載の数値につきましては、参考数値です。詳しい内容につきましては、仕様書、図面を参考して下さい。

2.本カタログ記載内容は、製品向上のため予告なく変更する事がありますのでご了承下さい。

Contents

CONTENTS

| Overview / 產品圖 | Series / 系列名稱 | Page / 頁數 |
|---|---|-----------|
|  | PLT-25◆ASeries Engineering Plastic 工程塑膠 PAT IP65 | 2-18 |
|  | PLT-30◆Series | 2-19 |
|  | PLT-30◆Series PLT-304E-RF-R PLT-307E-RF-R | 2-20 |
|  | PLT-30◆-PN PLT-30◆-RN Screw-Lockup-Contact Model 螺絲鎖附型 | 2-21 |
|  | PLT3106A / PLT3102A ◆ Series | 2-22 |
|  | PLT3106A / PLT3102A ◆ Series | 2-23 |
|  | PLT3106A / PLT3102A ◆ Series | 2-24 |
|  | PLT-32◆Series | 2-25 |
|  | PLT-40◆Series | 2-26 |

| Overview / 產品圖 | Series / 系列名稱 | Page / 頁數 |
|--|--|-----------|
|  | PLT-40◆Series | 2-27 |
|  | PLT-50◆Series | 2-28 |
| PLS Series Square Connectors / 方型連接器 3-1 | | |
| Overview / 產品圖 | Series / 系列名稱 | Page / 頁數 |
|  | NEW 新產品 PLS-20◆Series | 3-3 |
|  | NEW 新產品 PLS-20◆Series PLS-203E-RF-R PLS-207E-RF-R | 3-4 |
|  | PLS-24◆Series | 3-5 |
|  | PLS-24◆Series | 3-6 |
|  | PLS-27◆Series | 3-7 |
|  | PLS-28◆Series | 3-8 |
|  | PLS-28◆Series PLS-2812E-RF-R | 3-9 |

| Overview / 產品圖 | Series / 系列名稱 | Page / 頁數 |
|---|--|-----------|
|  | PLS-28◆Series Stainless Steel 不鏽鋼材質 | 3-10 |
|  | PLS-35◆Series | 3-11 |
|  | PLS-35◆Series | 3-12 |
|  | PLS-41◆Series | 3-13 |
|  | PLS-42◆Series | 3-14 |

| PLK Series Circular Connectors / 圓型連接器 4-1 | | |
|---|-----------------------------|-----------|
| Overview / 產品圖 | Series / 系列名稱 | Page / 頁數 |
|  | PLK-16◆-RA/PA Series | 4-3 |
|  | PLK-16◆Series | 4-4 |
|  | PLK-30◆Series | 4-5 |

| WPM Series Waterproof Connectors / 防水型連接器 5-1 | | |
|--|--|-----------|
| Overview / 產品圖 | Series / 系列名稱 | Page / 頁數 |
|  | WPM16A11-6PL-R WPM16A11-6SL-R WPM16A11-6R-R | 5-3 |
|  | WPM16C12-◆S-R WPM16C12-◆P-R | 5-4 |
|  | WPM-19◆-PM-R WPM-19◆-PF-R WPM-19◆-RF-R WPM-19◆-RM-R | 5-5 |
|  | WPM-19◆-SPM-R WPM-19◆-SPF-R | 5-6 |
|  | WPM-20◆Series | 5-7 |
|  | WPM-20◆Series | 5-8 |
|  | WPM-21◆Series | 5-9 |
|  | WPM-21◆Series Stainless Steel 不鏽鋼材質 | 5-10 |
|  | WPM-223◆Series | 5-11 |

● 備註：另有鎖側螺絲選項 Optional accessory: side screws
 ● 以上機種可設計防水型 Above models could be altered to waterproof types



專利產品 · 仿冒必究 Patent of invention, all rights reserved

Contents

CONTENTS

| Overview / 產品圖 | Series / 系列名稱 | Page / 頁數 |
|--|--------------------------------|-----------|
|  IP67 | WPM-223◆Series | 5-11 |
|  IP67 | WPM-305A-PF-R WPM-305A-RM-R | 5-12 |
|  IP67 | WPM-24◆-PM-R PLS-24◆-RF-R | 5-12 |
|  | WPM-1814 WPM-3831 | 5-13 |

WPS Series Waterproof Connectors / 防水型連接器 6-1

| Overview / 產品圖 | Series / 系列名稱 | Page / 頁數 |
|--|---------------|-----------|
|  RF IP67 PM | WPS-30◆-PM-R | 6-1 |

Complex Series / 綜合型號 7-1

| Overview / 產品圖 | Series / 系列名稱 | Page / 頁數 |
|---|--|-----------|
|  PAT | PLP-◆Series (INPUT TYPE) (OUTPUT TYPE) | 7-3 |
|  | PLP-141P◆ Series | 7-4 |
|  | PLP-154P◆ Series | 7-5 |
|  RF PM | M-6029 Series | 7-6 |

Others Series / 其他型號

| Overview / 產品圖 | Series / 系列名稱 | Page / 頁數 |
|---|-----------------------|-----------|
|  | U-C5 PLT-16-RCaC-R | 2-10 |

| Overview / 產品圖 | Series / 系列名稱 | Page / 頁數 |
|--|---|---|
|  | 防塵蓋(銅) Dust Cap(Copper) PLT-19-RCa-R | 2-15 |
|  | 防塵蓋(鋅) Dust Cap(Zinc) PLT-25C-RCa-R PLT-30C-RCa-R | 2-16、2-17 2-19、2-20 2-21、4-5 6-1 |
|  | 防塵蓋(塑膠) Dust Cap(Plastic) A-590PX A-591PX PAT | 2-16、2-17 2-19、2-20 2-21、4-5 6-1 |
|  | 防塵蓋(塑膠) Dust Cap(Plastic) PLT-25A-RCa-R PLT-30A-RCa-R | 2-16、2-17 2-19、2-20 2-21、4-5 6-1 |
|  | 防塵蓋(塑膠) Dust Cap(Plastic) A-587PX A-588PX A-589PX PAT | 3-3、3-4 3-5、3-6 3-8、3-9 |
|  | 防塵蓋(鋅) Dust Cap(Zinc) PLT-32C-RCaN-R PLT-40C-RCaC-R PLT-50-RCa | 2-25 2-26、2-27 2-28 |
|  | 防塵蓋(鋅) Dust Cap(Zinc) PLK-16C-RCaC-R | 4-4 |
|  | 防塵蓋(銅) Dust Cap(Brass) PLK-16-RCa-R | 4-4 |
|  | 防塵蓋(鋅) Dust Cap(Zinc) PLS-20C-RCaC-R PLS-24C-RCaC-R PLS-28C-RCa-R | 3-3、3-4 3-5、3-6 3-8、3-9 |
|  | 防塵蓋(鋁) Dust Cap(Aluminum) AMS25043-24AN-R | 3-11、3-12 |
|  | 防塵蓋(塑膠) IP67 Dust Cap(Plastic) WPM-19◆-RCa-R WPM-20◆-RCa-R | 5-5、5-6 5-7、5-8 |



線材穿過本體 Cable goes through the body

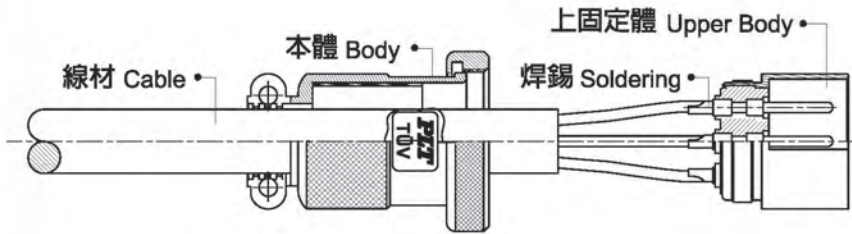

使用夾具將接頭夾持住，線材裸線與上固定體的接觸體缺口進行焊線加工
Using the clamp to fix the connector, doing soldering assembly between the bar wire and upper body.



本體與上固定體對鎖，將螺紋順時針方向鎖緊(需轉動本體鎖入，非轉動接頭)
The body and upper one are locked together. Screw clockwise and be sure to only rotate the body itself instead of the whole connector.



半月邊壓入(與線材不能留有間隙)
Crescent-shaped clamp mounted (The gap couldn't be allowed with the cable connected)

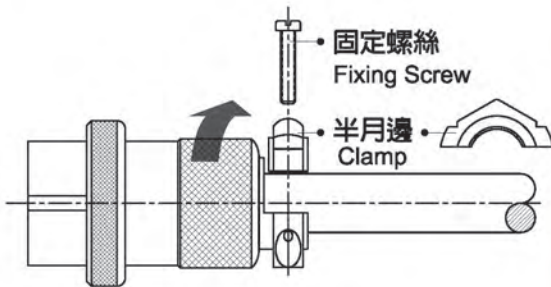

固定螺絲(圓頭十字 x 2支)鎖緊
With 2 screws (Round head) screwed tight



完成 Finish



⚠ 特別注意：拔出步驟說明 Pull-out instruction ⚠

插頭與插座要分開時，請將①固定帽依照③的方向旋開(如右圖)，再將②本體依左圖箭頭方向拉出，使插頭與插座分離。

While separating plug and receptacle, please have no. ① cup to rotate according to the direction as no. ③ specified. Then pull no. ② body to remove the plug and receptacle.



(注意! ①固定帽未旋開，勿轉動②本體，①固定帽鬆開後方可拉出。切記! 請勿直接旋開②本體，避免線材因扭轉導致斷裂)
Notice !! Don't screw off the body itself, in case the cable would be broken while twisting

Instruction

Plug Female Contact

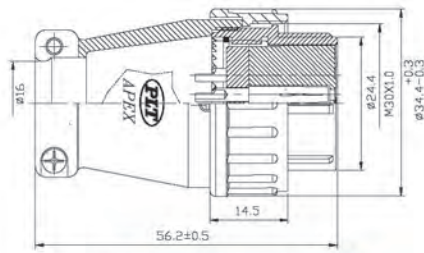

PLS-28 ◆ -PF X-R

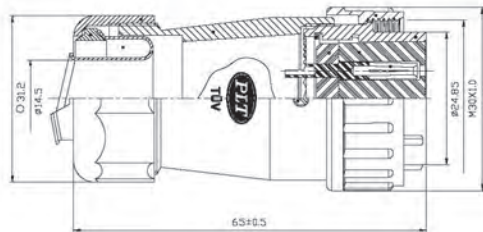

PLS-28 ◆ -GPF X-R

Socket Male Contact

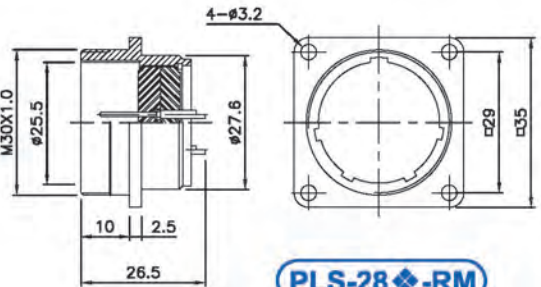

PLS-28 ◆ -RM

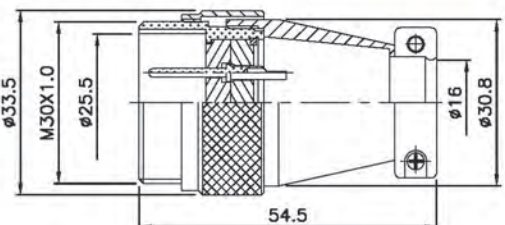

PLS-28 ◆ -ADM

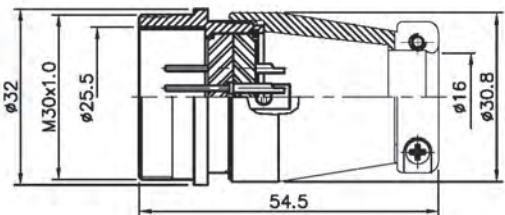

Please select the required contact no. from the below column
請從下列的欄位中選擇一個適當的接點

Nomenclature 表示方法
PLS-28 ◆ -GPF

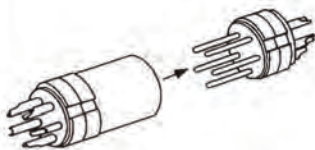

The insertion between male, and female contacts.
母導梢與公導針對接

⚠ WARNING : Electric Shock Hazard, Do Not Hot Plugging.

⚠ 警告：為避免觸電，通電狀態下禁止插拔電源線連接器。

⚠ 警告：感電の恐れがありますので、通電中に電源コードの挿抜を行わないでください。

The assembly may not be proceeded when the direction of arrows are identical.
此外，當箭頭的方向相同時，則無法組合

(TUV Approved)

UL : (UL Approved)

| ◆ No. of contacts 接點數目 | 12 | 16 | 17 | 20 | 26 |
|---|----------|---------|---------|---------|---------|
| Contacts Configuration 接點方位 | | | | | |
| Rated current / voltage 額定電流 / 電壓 | 10A 250V | 5A 250V | 5A 250V | 5A 250V | 5A 250V |
| Operating voltage limit (AC.V,rms) 操作電壓限制 | 250 | 250 | 250 | 250 | 250 |
| Withstanding voltage (AC.V,rms) 1 minute 耐電壓1分鐘 | 1000 | 1000 | 1000 | 1000 | 1000 |
| Insulation resistance (MΩ MIN.) at DC 500V 絕緣阻抗 | 1000 | 1000 | 1000 | 1000 | 1000 |
| Contact resistance (mΩ MAX.) at DC 1A 接觸阻抗 | 5 | 5 | 5 | 3 | 3 |
| Solder internal diameter 焊孔內徑 | 1.6 | 1.6 | 1.6 | 1.2 | 1.2 |



PLT-8 Series



PLT-9 Series



PLT-10 Series



PLT-11 Series



PLT-14 Series



PLT-15 Series



PLT-15.5 Series



PLT-16 Series



PLT-16A Series



Engineering Plastic 工程塑膠

PLT-17 Series



PLT-18 Series



PLT-19 Series



PLT-25 Series



PAT

PLT-25A Series



PLT-30 Series



Screw-Lockup-Contact Model
螺絲鎖附型

PLT-303 Series



PLT-31 Series



PLT-32 Series



PLT-40 Series



PLT-50 Series



WGP

防水電氣尼龍配管
Waterproof Corrugated Nylon Tube



GP

防水防爆電氣配管
Waterproof Explosionproof Tube
with Steel Wire Braiding



CG

耐扭試電纜固定頭
Flex Protecting Cable Glands



● ORDERING INFORMATION

PLT-162-P-R

- RoHS 2.0 COMPLIANT 歐盟環保指令
- CONNECTOR TYPE 連接器類型 (Reference 參考 ● 圖一)
- NO. OF CONTACTS (2-37) 導梢數量
- SHELL SIZE (8,9,11,15,16,17,18,19,25,3,32,40,50) 外殼尺寸
- NAME OF SERIES 系列名稱

● 圖一

| | | | | | |
|------------|--------------------------------|----------|-----------|-------------------|------|
| PM | Plug Male | 插頭導針 | RM | Receptacle Male | 插座導針 |
| PF | Plug Female | 插頭導梢 | RF | Receptacle Female | 插座導梢 |
| P | Plug | 插 頭 | AD | Adapter | 中 繼 |
| R | Receptacle (Front mounting) | 插座 (前裝式) | Ca | Cap | 保護蓋 |
| RL | Receptacle (Rear mounting) | 插座 (後裝式) | RT | Rubber tube | 橡膠管 |
| WGP | Nylon type | 尼龍管式 | GP | Conduit type | 軟管式 |
| LP | L Shape | L型90° | CG | Cable glands | 迫緊頭 |

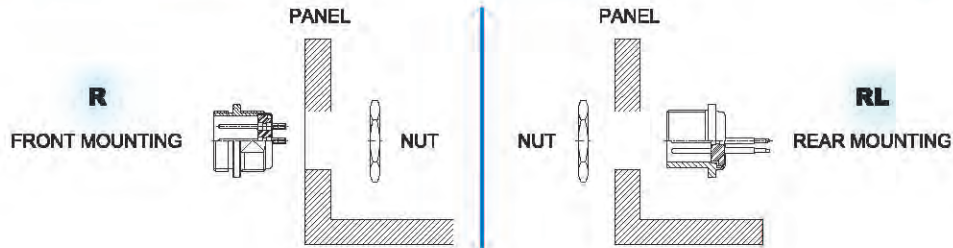

● MATERIAL & FINISH

Kindly refer to the below column for material & finish when ordering

| Description | Material | Finish |
|-----------------|---|--|
| Shell / 外殼、本體 | <ul style="list-style-type: none"> • Stainless Steel / 不鏽鋼 • Zinc alloy Die Casting / 鋅合金壓鑄 • Aluminum alloy Die Casting / 鋁合金壓鑄 | <ul style="list-style-type: none"> • Chrome-plated / 鍍鉻 • Gold-plated / 鍍金 • Nickel-plated / 鍍鎳 • Silver-plated / 鍍銀 |
| Insulator / 絕緣體 | <ul style="list-style-type: none"> • Bakelite / 電木 • Delrin / 塑膠 • Teflon / 鐵氟龍 | |
| Contact / 接點 | <ul style="list-style-type: none"> • Copper / 銅 • Phosphor Copper / 磷青銅 • Beryllium Copper / 鈹銅 | <ul style="list-style-type: none"> • Gold-plated / 鍍金 • Nickel-plated / 鍍鎳 • Silver-plated / 鍍銀 |

▲ **WARNING** : Electric Shock Hazard, Do Not Hot Plugging.

▲ 警告：為避免觸電，通電狀態下禁止插拔電源線連接器。

▲ 警告：感電の恐れがありますので、通電中に電源コードの挿抜を行わないでください。



PLT-8 Series

Socket Female Contact

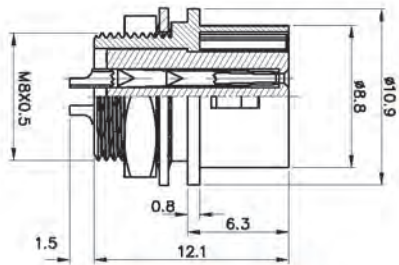

PLT-8◆-RF-R

Plug Male Contact

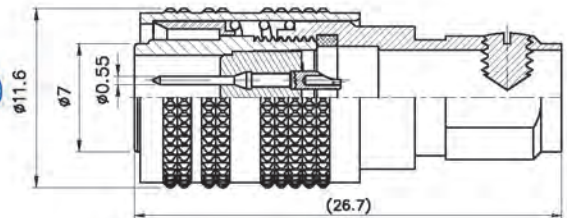

PLT-8◆-PM-R

Plug Female Contact

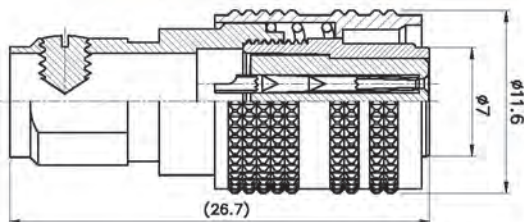

PLT-8◆-PF-R



Socket Male Contact

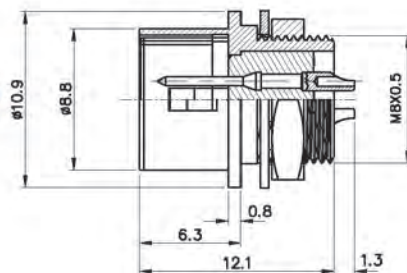

PLT-8◆-RM-R

ACCESSORIES:

Cable Clamp

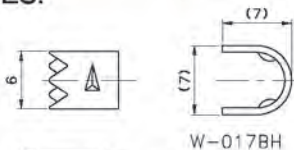

Rubber Pipe

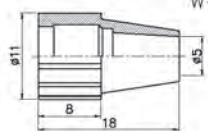

W-017BH

| ◆ No. of contacts | 4 | 5 | 6 | | | | |
|--|---------|---------|---------|--|--|--|--|
| Contacts Configuration | | | | | | | |
| Rated current / voltage | 2A 125V | 2A 125V | 2A 125V | | | | |
| Operating voltage limit (AC.V.rms) | 125 | 125 | 125 | | | | |
| Withstanding voltage (AC.V. rms) 1 minute | 500 | 500 | 500 | | | | |
| Insulation resistance (MΩ MIN.) at DC 500V | 1000 | 1000 | 1000 | | | | |
| Contact resistance (mΩ MAX.) at DC 1A | 10 | 10 | 10 | | | | |



Socket Female Contact

Plug Male Contact



WPM-94-RF-R

WPM-94-PM-R

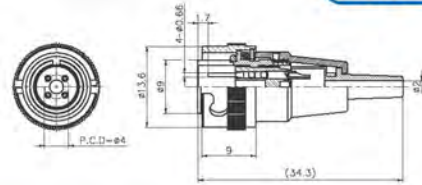
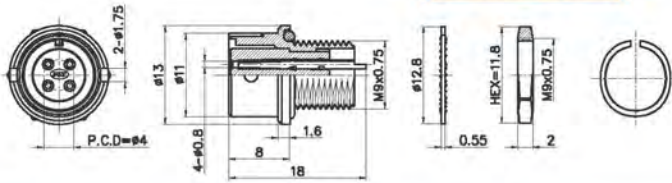

| | | | | | | | |
|--|--------------------|--|--|--|--|--|--|
| No. of contacts | 4 | | | | | | |
| Contacts Configuration | | | | | | | |
| Rated current / voltage | 1A 300V | | | | | | |
| Operating voltage limit (AC.V.rms) | AC 100V DC 140V | | | | | | |
| Withstanding voltage (AC.V. rms) 1 minute | 300 | | | | | | |
| Insulation resistance (MΩ MIN.) at DC 500V | 200 | | | | | | |
| Contact resistance (mΩ MAX.) at DC 1A | 10 | | | | | | |

Plug Male Contact

Socket Female Contact



Note:

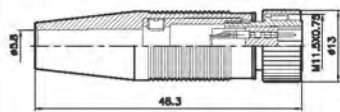
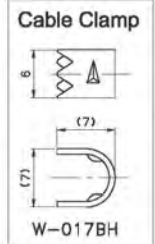

PLT-9-P-R

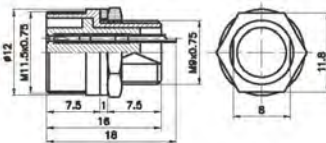
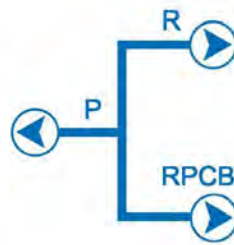

PLT-9-R-R

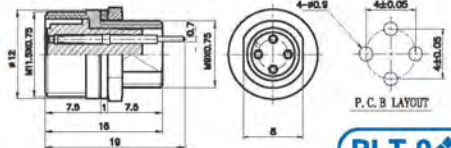

PLT-9-RPCB

| | | | | | | | |
|--|---------|---------|---------|--|--|--|--|
| No. of contacts | 4 | 6 | 7 | | | | |
| Contacts Configuration | | | | | | | |
| Rated current / voltage | 1A 300V | 1A 300V | 1A 300V | | | | |
| Operating voltage limit (AC.V.rms) | 300 | 300 | 300 | | | | |
| Withstanding voltage (AC.V. rms) 1 minute | 200 | 200 | 200 | | | | |
| Insulation resistance (MΩ MIN.) at DC 500V | 10 | 10 | 10 | | | | |
| Contact resistance (mΩ MAX.) at DC 1A | 0.7 | 0.7 | 0.7 | | | | |

10

PLT-10 Series

2
PLT SERIES

Socket Female Contact

Plug Male Contact

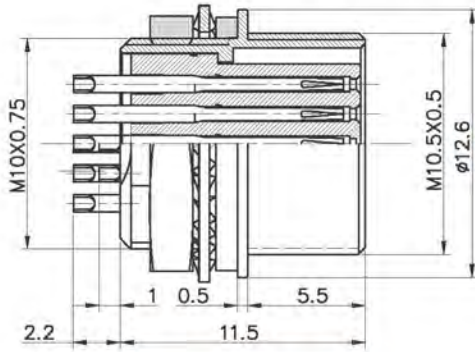

PLT-10-RF-R

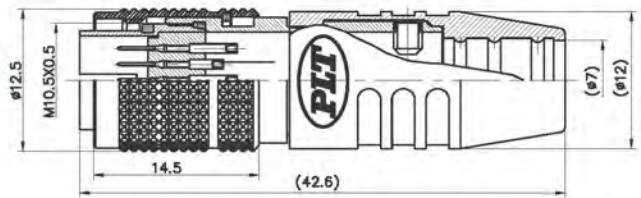

PLT-10-PM-R

Plug Female Contact

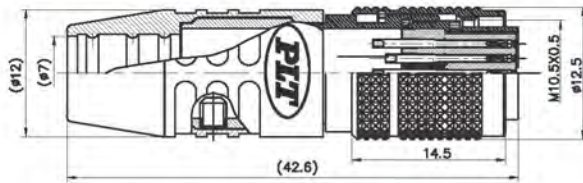

PLT-10-PF-R



Socket Male Contact

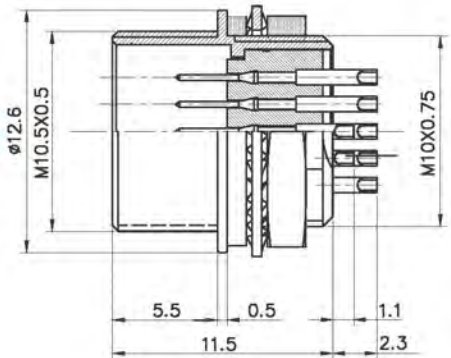

PLT-10-RM-R

Note:

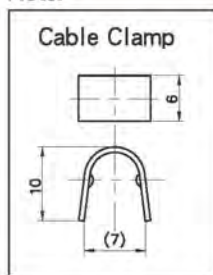

| | | | | | | | | |
|--|--------|--|--|--|--|--|--|--|
| ◆ No. of contacts | 16 | | | | | | | |
| Contacts Configuration | | | | | | | | |
| Rated current / voltage | 1A 30V | | | | | | | |
| Operating voltage limit (AC.V.rms) | 42V | | | | | | | |
| Withstanding voltage (AC.V. rms) 1 minute | 100 | | | | | | | |
| Insulation resistance (MΩ MIN.) at DC 500V | 1000 | | | | | | | |
| Contact resistance (mΩ MAX.) at DC 1A | 30 | | | | | | | |

Plug Female Contact



PLT-11◆-RF-R

Plug Male Contact

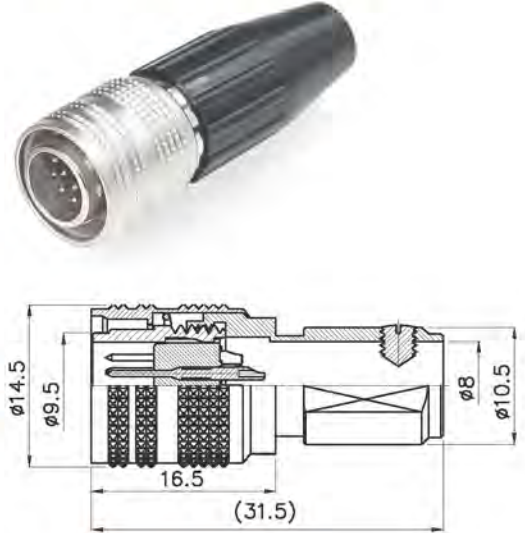

PLT-11◆-PM-R

Adapter Female Contact

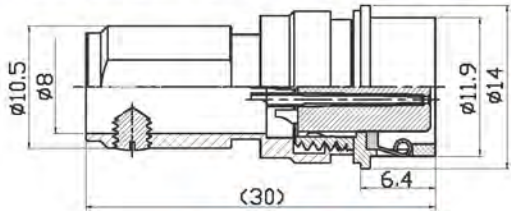

PLT-11◆-ADF-R

Adapter Male Contact

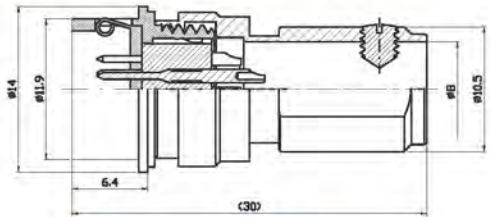

PLT-11◆-ADM-R

Plug Female Contact

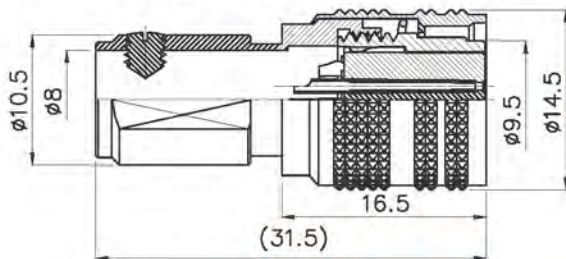

PLT-11◆-PF-R

Socket Male Contact

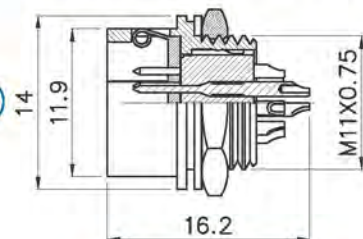

PLT-11◆-RM-R

ACCESSORIES:

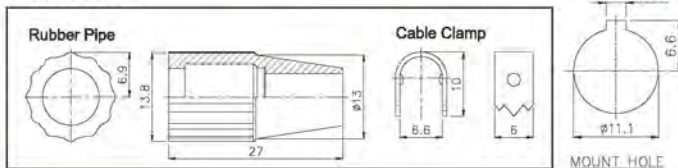

MOUNT HOLE

| ◆ No. of contacts | 10 | 12 | 16 | | | | |
|--|---------|---------|--------|--|--|--|--|
| Contacts Configuration | | | | | | | |
| Rated current / voltage | 2A 125V | 2A 125V | 1A 30V | | | | |
| Operating voltage limit (AC.V.rms) | 125 | 125 | 125 | | | | |
| Withstanding voltage (AC.V. rms) 1 minute | 125 | 125 | 100 | | | | |
| Insulation resistance (MΩ MIN.) at DC 500V | 200 | 200 | 1000 | | | | |
| Contact resistance (mΩ MAX.) at DC 1A | 30 | 30 | 30 | | | | |

14

PLT-14 Series

Plug Male Contact

Adapter Female Contact

2
PLT SERIES

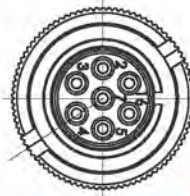
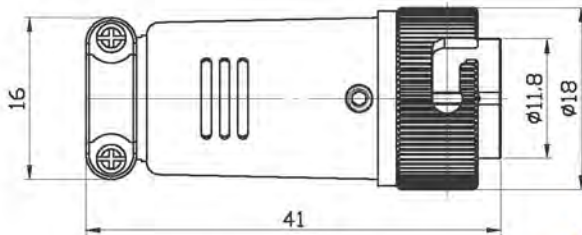

PLT-14 ◆ -PM-R

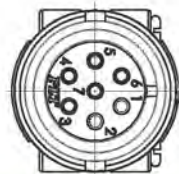
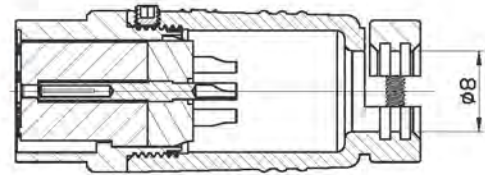
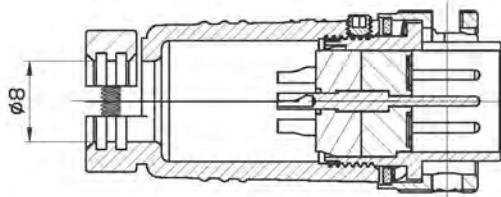

PLT-14 ◆ -ADF-R

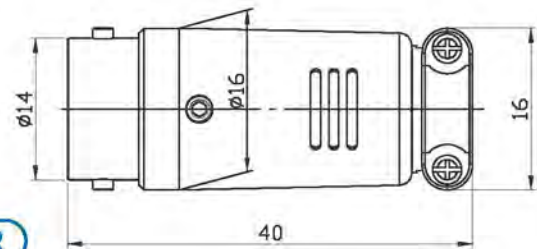

| ◆ No. of contacts | 3 | 4 | 7 | | | | |
|--|---------|---------|---------|--|--|--|--|
| Contacts Configuration | | | | | | | |
| Rated current / voltage | 5A 125V | 5A 125V | 5A 125V | | | | |
| Operating voltage limit (AC.V.rms) | 300 | 300 | 300 | | | | |
| Withstanding voltage (AC.V. rms) 1 minute | 1500 | 1500 | 1000 | | | | |
| Insulation resistance (MΩ MIN.) at DC 500V | 1000 | 1000 | 1000 | | | | |
| Contact resistance (mΩ MAX.) at DC 1A | 4 | 4 | 4 | | | | |

Plug Female Contact

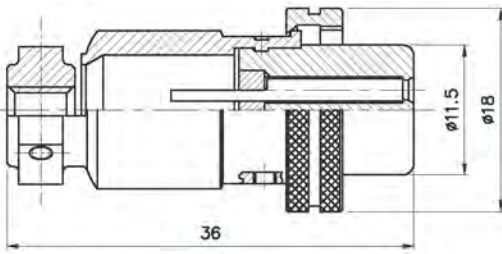

PLT-15-P-R

Socket Male Contact

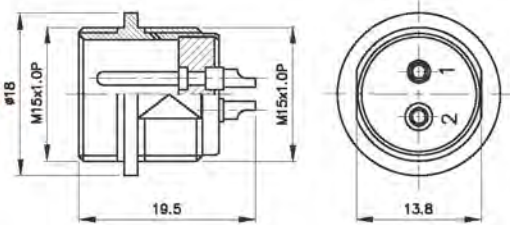

PLT-15-R-R

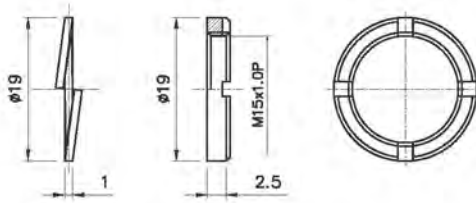

ACCESSORIES

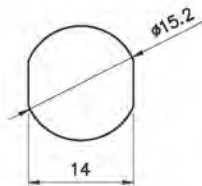

MOUNTING HOLES



Adapter Male Contact



PLT-15-AD-R

| No. of contacts | 2 | 3 | 4 | | | | |
|--|-----------|-----------|---------|--|--|--|--|
| Contacts Configuration | | | | | | | |
| Rated current / voltage | 5A 125V | 5A 125V | 5A 125V | | | | |
| Operating voltage limit (AC.V.rms) | 200 | 200 | 200 | | | | |
| Withstanding voltage (AC.V. rms) 1 minute | 1000 | 1000 | 1000 | | | | |
| Insulation resistance (MΩ MIN.) at DC 500V | 100 | 100 | 100 | | | | |
| Contact resistance (mΩ MAX.) at DC 1A | 10 | 10 | 10 | | | | |
| Solder internal diameter | 1.8 / 2.3 | 1.8 / 2.3 | 1.5 | | | | |

15.5

PLT-15.5 Series

Adapter Male Contact

Plug Female Contact

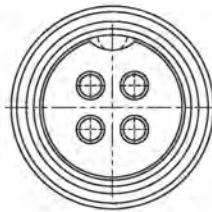
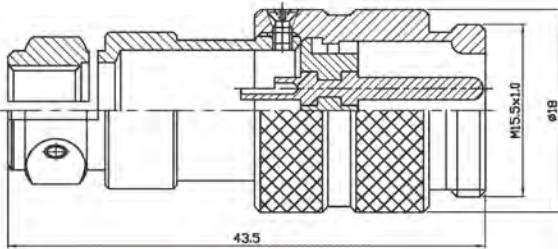

PLT-15.5-4AD-R

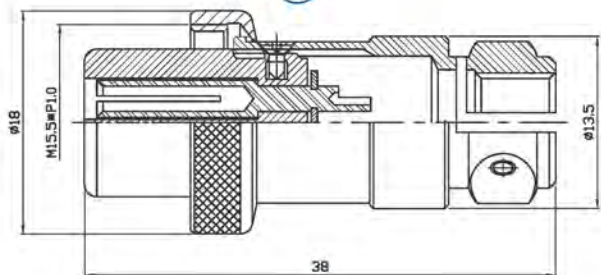
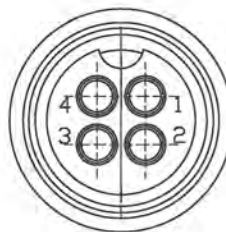

PLT-15.5-4P-R

| ◆ No. of contacts | 2 | 4 | | | | | | |
|--|---------|---------|--|--|--|--|--|--|
| Contacts Configuration | | | | | | | | |
| Rated current / voltage | 5A 125V | 5A 150V | | | | | | |
| Operating voltage limit (AC.V.rms) | 200 | 200 | | | | | | |
| Withstanding voltage (AC.V. rms) 1 minute | 1000 | 1000 | | | | | | |
| Insulation resistance (MΩ MIN.) at DC 500V | 1000 | 1000 | | | | | | |
| Contact resistance (mΩ MAX.) at DC 1A | 3 | 3 | | | | | | |
| Solder internal diameter | 1.5 | 1 | | | | | | |

Plug Female Contact

Socket Male Contact

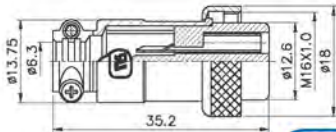

PLT-16-P-R

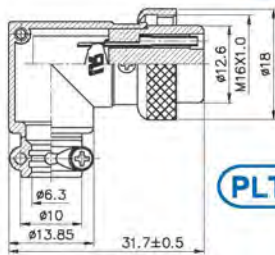

PLT-16-LP-R

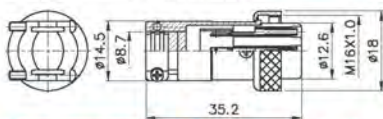

PLT-16-PA-R

Material: Zinc Alloy
材質: 鋅合金

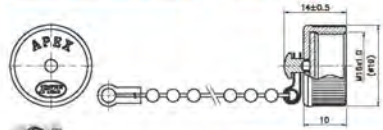

PLT-16-RCaC-R

Material: Zinc Alloy
材質: 鋅合金

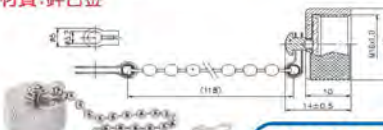

PLT-16-RCa-R

Material: Brass
材質: 銅

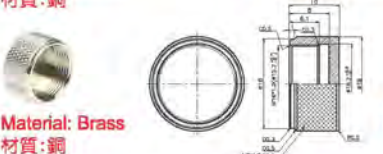

U-C5

Material: Brass
材質: 銅

Stainless Steel 不鏽鋼材質

| | | | | | | | |
|-----|------|------|------|------|----|----|----|
| PIN | 2 | 3 | 4 | 5 | 6 | 7 | 8 |
| L | 20.5 | 20.5 | 20.5 | 20.5 | 19 | 19 | 19 |

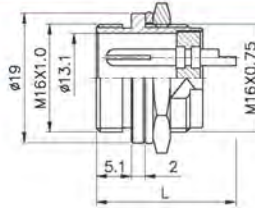

PLT-16-R-R

MOUNTING HOLES

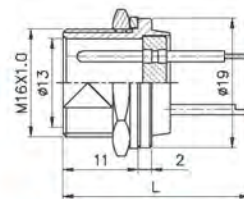

PLT-16-RL-R

*A: PCB TYPE *B: SOLDERING TYPE

FORM 1 FOR PLT-16-R-L

| | | | | | | |
|--------|------|------|----|------|------|------|
| LENGTH | L1 | L2 | L3 | L4 | L5 | L6 |
| SIZE | 20.5 | 23.5 | 29 | 30.5 | 21.5 | 21.5 |

*FORM 2 (ACCESSORIES)

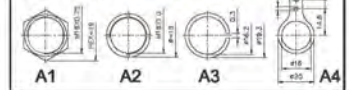

Adapter Male Contact

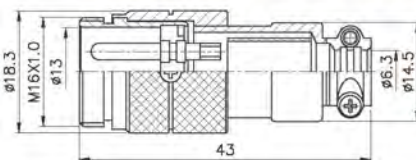

PLT-16-AD-R

PD:98441

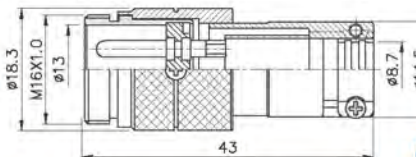

PLT-16-ADA-R

| ◆ No. of contacts | 2 | 3 | 4 | 5 | 6 | 7 | 8 |
|--|---------|---------|---------|---------|---------|---------|---------|
| Contacts Configuration | | | | | | | |
| Rated current / voltage | 5A 125V | 5A 125V | 5A 125V | 5A 125V | 5A 125V | 5A 125V | 5A 125V |
| Operating voltage limit (AC.V.rms) | 200 | 200 | 200 | 200 | 200 | 200 | 200 |
| Withstanding voltage (AC.V. rms) 1 minute | 1000 | 1000 | 1000 | 1000 | 1000 | 1000 | 1000 |
| Insulation resistance (MΩ MIN.) at DC 500V | 1000 | 1000 | 1000 | 1000 | 1000 | 1000 | 1000 |
| Contact resistance (mΩ MAX.) at DC 1A | 3 | 3 | 3 | 3 | 3 | 3 | 3 |
| Solder internal diameter | 1.4 | 1.4 | 1.4 | 1.2 | 0.8 | 0.8 | 0.8 |

16

PLT-16 Series

Plug Male Contact

Socket Female Contact

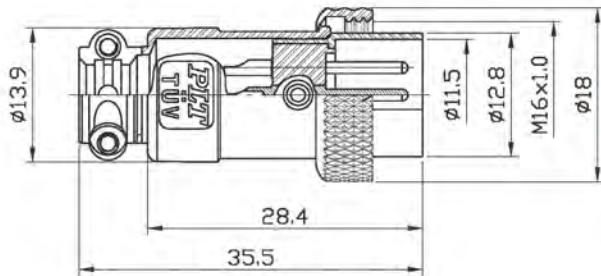

PLT-16◆-PM-R

PM

RLF

RF

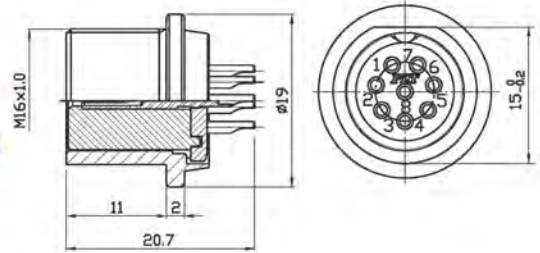

PLT-16◆-RLF-R

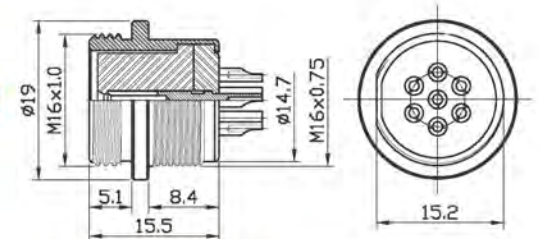

PLT-16◆-RF-R

| ◆ No. of contacts | 2 | 3 | 4 | 5 | 6 | 7 | 8 | |
|--|---------|---------|---------|---------|---------|---------|---------|--|
| Contacts Configuration | | | | | | | | |
| Rated current / voltage | 5A 125V | 5A 125V | 5A 125V | 5A 125V | 5A 125V | 5A 125V | 5A 125V | |
| Operating voltage limit (AC.V.rms) | 200 | 200 | 200 | 200 | 200 | 200 | 200 | |
| Withstanding voltage (AC.V. rms) 1 minute | 1000 | 1000 | 1000 | 1000 | 1000 | 1000 | 1000 | |
| Insulation resistance (MΩ MIN.) at DC 500V | 1000 | 1000 | 1000 | 1000 | 1000 | 1000 | 1000 | |
| Contact resistance (mΩ MAX.) at DC 1A | 3 | 3 | 3 | 3 | 3 | 3 | 3 | |
| Solder internal diameter | 1.4 | 1.4 | 1.4 | 1.2 | 0.8 | 0.8 | 0.8 | |

Plug Male Contact

Socket Female Contact

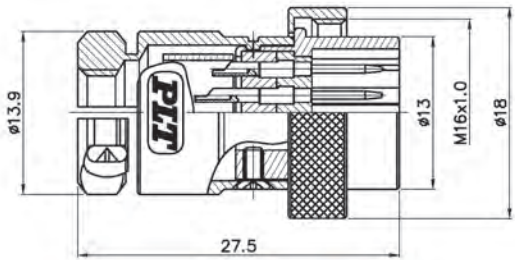

PLT-16A-PM-R

PM

RF

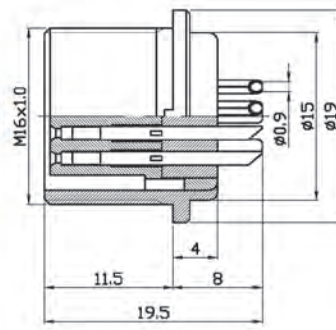

PLT-16A-RF-R

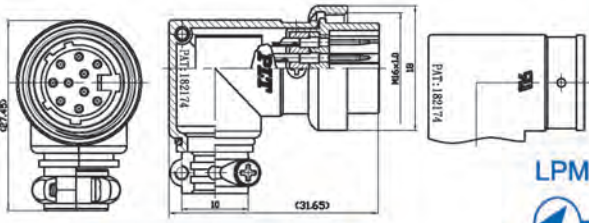
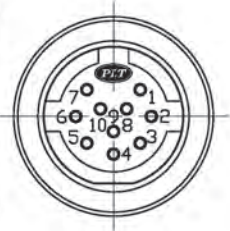

PLT-16A-LPM-R

LPM-R

| | | | | | | | | |
|--|---------|--|--|--|--|--|--|--|
| ◆ No. of contacts | 10 | | | | | | | |
| Contacts Configuration | | | | | | | | |
| Rated current / voltage | 3A 125V | | | | | | | |
| Operating voltage limit (AC.V.rms) | 200 | | | | | | | |
| Withstanding voltage (AC.V. rms) 1 minute | 1000 | | | | | | | |
| Insulation resistance (MΩ MIN.) at DC 500V | 100 | | | | | | | |
| Contact resistance (mΩ MAX.) at DC 1A | 10 | | | | | | | |
| Solder internal diameter | 0.9 | | | | | | | |

17

PLT-17 Series

Plug Female Contact

Socket Male Contact

2
PLT SERIES

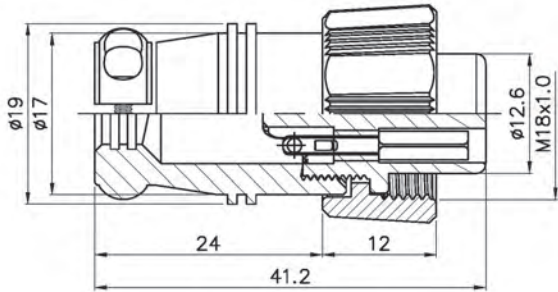

PLT-17◆-P-R

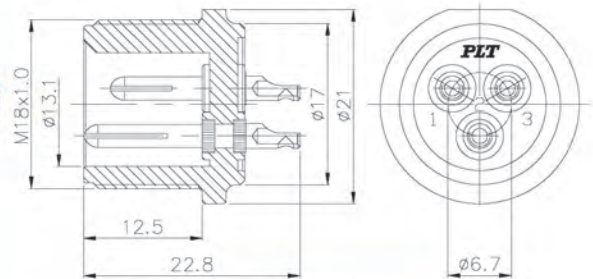

PLT-17◆-R-R

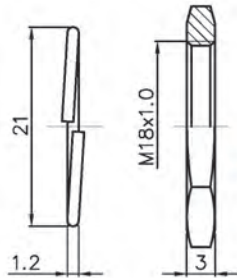

ACCESSORIES

(Engineering Plastic 工程塑膠)

| | | | | | | | | |
|--|---------|---------|--|--|--|--|--|--|
| ◆ No. of contacts | 3 | 6 | | | | | | |
| Contacts Configuration | | | | | | | | |
| Rated current / voltage | 6A 125V | 6A 125V | | | | | | |
| Operating voltage limit (AC.V.rms) | 200 | 200 | | | | | | |
| Withstanding voltage (AC.V. rms) 1 minute | 1000 | 1000 | | | | | | |
| Insulation resistance (MΩ MIN.) at DC 500V | 1000 | 1000 | | | | | | |
| Contact resistance (mΩ MAX.) at DC 1A | 3 | 3 | | | | | | |
| Solder internal diameter | 1.4 | 0.8 | | | | | | |

Socket Female Contact

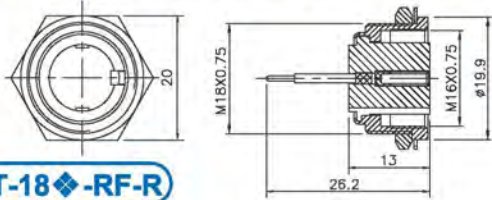

PLT-18-RF-R

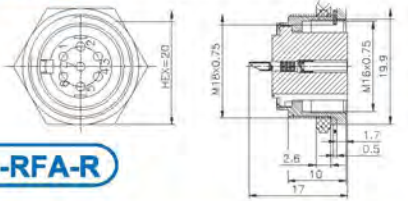

PLT-18-RFA-R

Adapter Female Contact

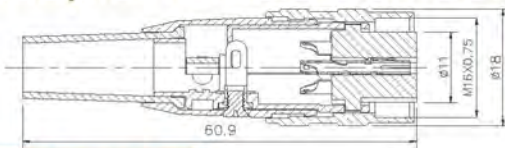

PLT-18-ADF-R

Plug Male Contact

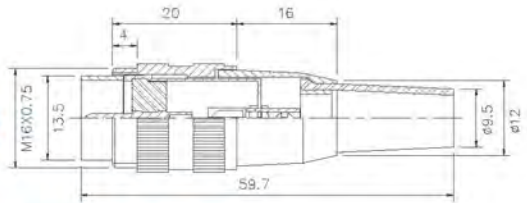

PLT-18-PM-R



Plug Female Contact

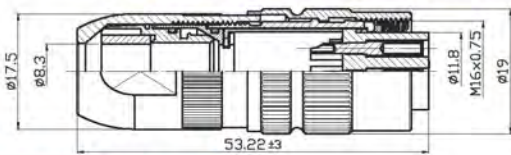

PLT-18-A-PF-R

Socket Female Contact

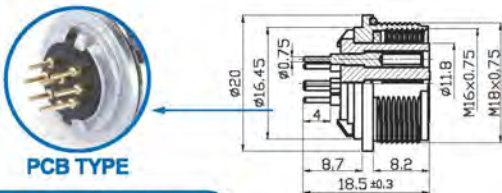

PCB TYPE

PLT-18-A-RF-R

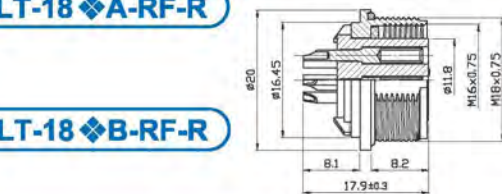

PLT-18-B-RF-R

Socket Male Contact

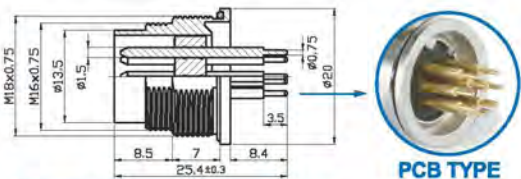

PCB TYPE

PLT-18-A-RM-R IP67

Plug Male Contact

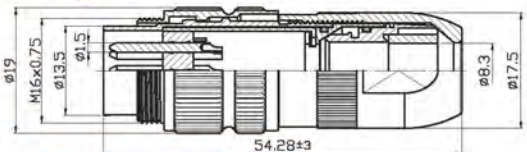

PLT-18-A-PM-R



| No. of contacts | 5 | 7 | 8 | | | | | |
|--|---------|---------|---------|--|--|--|--|--|
| Contacts Configuration | | | | | | | | |
| Rated current / voltage | 5A 125V | 5A 125V | 5A 125V | | | | | |
| Operating voltage limit (AC.V.rms) | 200 | 200 | 200 | | | | | |
| Withstanding voltage (AC.V. rms) 1 minute | 1000 | 1000 | 1000 | | | | | |
| Insulation resistance (MΩ MIN.) at DC 500V | 1000 | 1000 | 1000 | | | | | |
| Contact resistance (mΩ MAX.) at DC 1A | 3 | 3 | 3 | | | | | |
| Solder internal diameter | 1.55 | 1.55 | 1.55 | | | | | |

19

PLT-19 Series

2
PLT SERIES

Plug Female Contact

Socket Male Contact

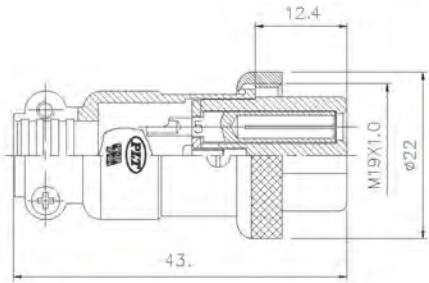

PLT-19-P-R

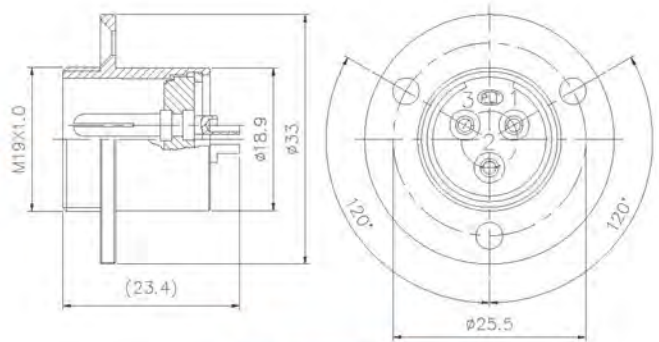

PLT-19-R-R

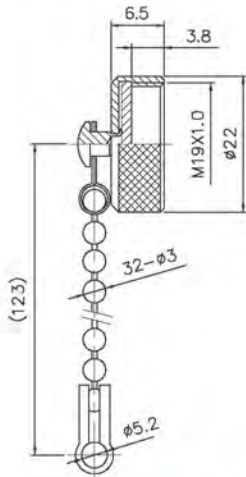

PLT-19-RCa-R

Material: Copper Alloy
材質: 銅合金

Adapter Male Contact

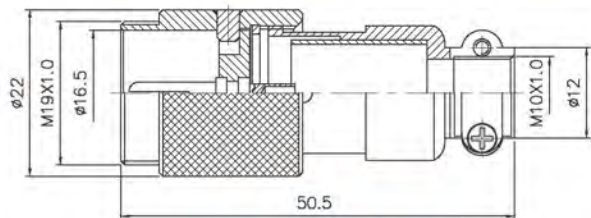

PLT-19-AD-R



| ◆ No. of contacts | 2 | 3 | 4 | | | | |
|--|--------------|--------------|--------------|--|--|--|--|
| Contacts Configuration | | | | | | | |
| Rated current / voltage | TÜV 7A 250V | TÜV 7A 250V | TÜV 7A 250V | | | | |
| Operating voltage limit (AC.V.rms) | 250 | 250 | 250 | | | | |
| Withstanding voltage (AC.V. rms) 1 minute | 1000 | 1000 | 1000 | | | | |
| Insulation resistance (MΩ MIN.) at DC 500V | 1000 | 1000 | 1000 | | | | |
| Contact resistance (mΩ MAX.) at DC 1A | 3 | 3 | 3 | | | | |
| Solder internal diameter | 1.7 | 1.7 | 1.7 | | | | |

Plug Female Contact

Socket Male Contact

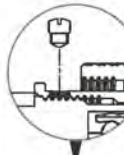

●另有鎖側螺絲選項
Optional accessory: side screws

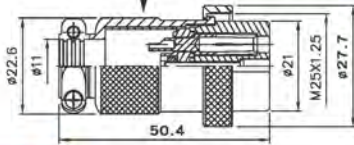

PLT-25-P-R

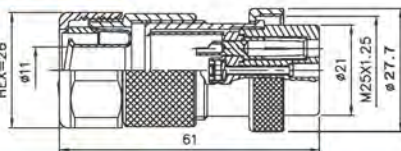

PLT-25-GP3-R 3=轉接3/8"軟管
Connected with 3/8" conduit

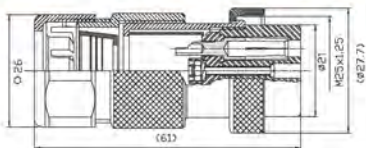

PLT-25-WGPF3-R 3=轉接3/8"尼龍管
Connected with 3/8" nylon tube

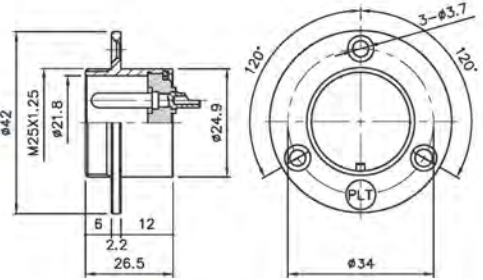
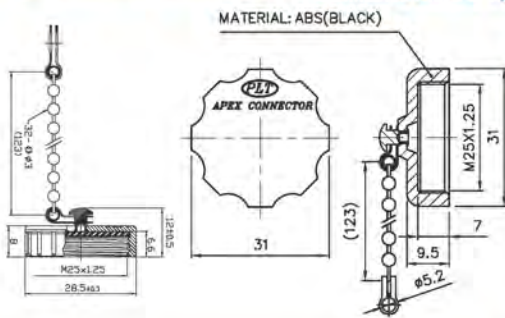

PLT-25-R-R

Adapter Male Contact

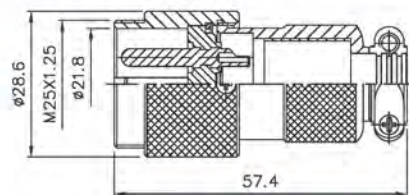

PLT-25-AD-R

Material: Plastic
材質: 塑膠



PLT-25A-RCa-R

Material: Zinc Alloy
材質: 鋅合金



PLT-25C-RCa-R

Material: Plastic
材質: 塑膠



PAT A-590PX

| No. of contacts | 2 | 3 | 4 | 5 | 6 | | |
|--|----------|----------|----------|----------|----------|--|--|
| Contacts Configuration | | | | | | | |
| Rated current / voltage | 10A 250V | 10A 250V | 10A 250V | 10A 250V | 10A 250V | | |
| Operating voltage limit (AC.V.rms) | 400 | 400 | 400 | 400 | 300 | | |
| Withstanding voltage (AC.V. rms) 1 minute | 2000 | 2000 | 2000 | 1800 | 1800 | | |
| Insulation resistance (MΩ MIN.) at DC 500V | 2000 | 2000 | 2000 | 2000 | 2000 | | |
| Contact resistance (mΩ MAX.) at DC 1A | 3 | 3 | 3 | 3 | 3 | | |
| Solder internal diameter | 1.9 | 1.9 | 1.9 | 1.9 | 1.9 | | |

25

PLT-25 Series

Socket Female Contact

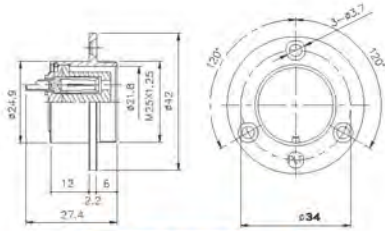

PLT-25 ◆ -RF-R

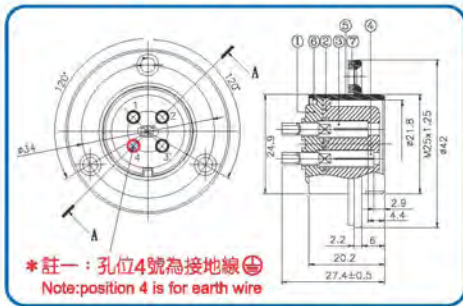

PLT-254E-RF-R

Adapter Female Contact

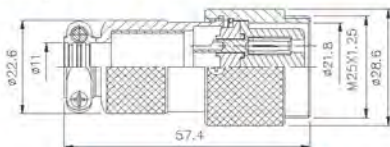

PLT-25 ◆ -ADF-R

Material: Zinc Alloy
材質：鋅合金



PLT-25C-RCa-R

Material: Plastic
材質：塑膠



PAT A-590PX

Material: Plastic
材質：塑膠



PLT-25A-RCa-R

Plug Male Contact



另有鎖側螺絲選項
Optional accessory: side screws

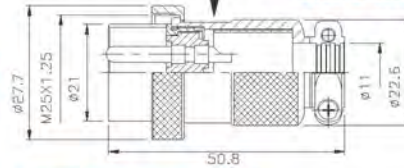

PLT-25 ◆ -PM-R

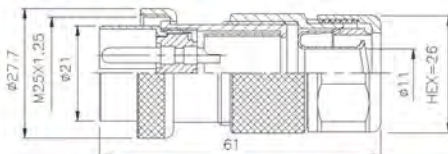

PLT-25 ◆ -GPM3-R

3=轉接3/8"軟管
Connected with 3/8" conduit

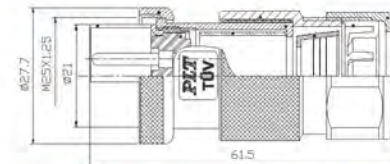

PLT-25 ◆ -WGPM3-R

3=轉接3/8"尼龍管
Connected with 3/8" nylon tube

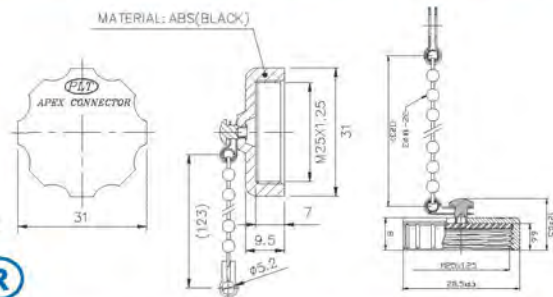

| ◆ No. of contacts | 2 | 3 | 4 | 5 | 6 | | | |
|--|----------|----------|----------|----------|----------|--|--|--|
| Contacts Configuration | | | | | | | | |
| Rated current / voltage | 10A 250V | 10A 250V | 10A 250V | 10A 250V | 10A 250V | | | |
| Operating voltage limit (AC.V.rms) | 400 | 400 | 400 | 400 | 300 | | | |
| Withstanding voltage (AC.V. rms) 1 minute | 2000 | 2000 | 2000 | 1800 | 1800 | | | |
| Insulation resistance (MΩ MIN.) at DC 500V | 2000 | 2000 | 2000 | 2000 | 2000 | | | |
| Contact resistance (mΩ MAX.) at DC 1A | 3 | 3 | 3 | 3 | 3 | | | |
| Solder internal diameter | 1.9 | 1.9 | 1.9 | 1.9 | 1.9 | | | |

2
PLT SERIES



Socket Male Contact

Plug Female Contact

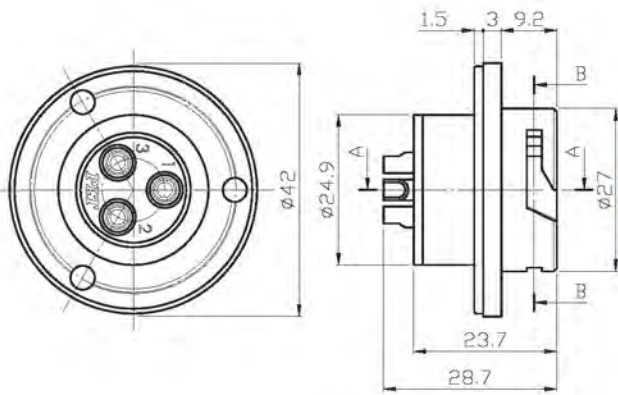

PLT-25◆A-R-R

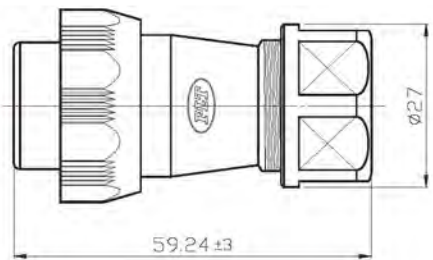

PLT-25◆A-P-R

(Engineering Plastic 工程塑膠)

| ◆ No. of contacts | 3 | 4 | | | | | | |
|--|----------|----------|--|--|--|--|--|--|
| Contacts Configuration | | | | | | | | |
| Rated current / voltage | 10A 250V | 10A 250V | | | | | | |
| Operating voltage limit (AC.V.rms) | 200 | 200 | | | | | | |
| Withstanding voltage (AC.V. rms) 1 minute | 1000 | 1000 | | | | | | |
| Insulation resistance (MΩ MIN.) at DC 500V | 1000 | 1000 | | | | | | |
| Contact resistance (mΩ MAX.) at DC 1A | 3 | 3 | | | | | | |

30

PLT-30 Series

Plug Female Contact

Socket Male Contact

2
PLT SERIES



另有鎖側螺絲選項
Optional accessory: side screws

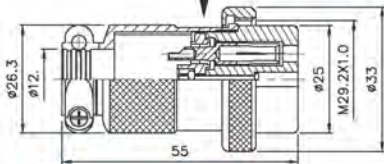

PLT-30-P-R

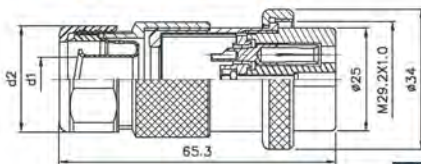

PLT-30-GP-R

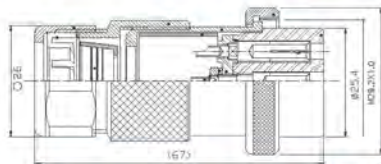

PLT-30-WGP-R

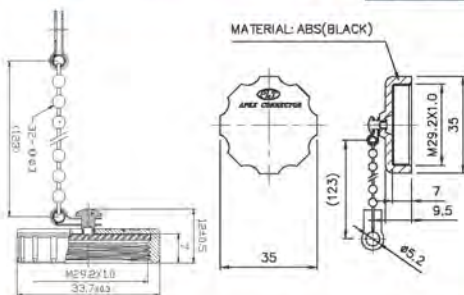

MATERIAL: ABS(BLACK)

軟管 / Conduit

| | | |
|-----------|-------|-------|
| 3 3/8" 軟管 | d1 | d2 |
| | Ø10.8 | Ø26.3 |
| 4 1/2" 軟管 | d1 | d2 |
| | Ø14.3 | Ø31.2 |

尼龍管 / Nylon Tube

| | | |
|-----------|-------|-------|
| 3 3/8" 軟管 | d1 | d2 |
| | Ø10.8 | Ø26.3 |
| 4 1/2" 軟管 | d1 | d2 |
| | Ø14.3 | Ø31.2 |

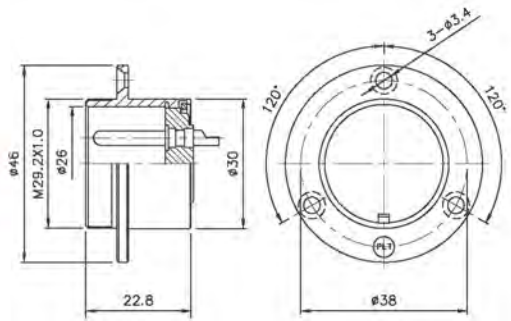
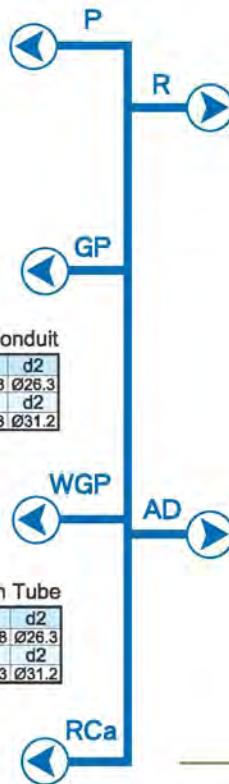

PLT-30-R-R

Adapter Male Contact

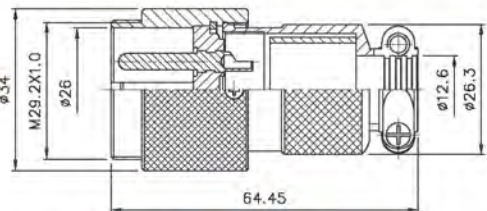

PLT-30-AD-R

Material: Plastic
材質: 塑膠



PLT-30A-RCa-R

Material: Zinc Alloy
材質: 鋅合金



PLT-30C-RCa-R



PAT A-591PX

| No. of contacts | 2 | 3 | 4 | 5 | 8 | | | |
|--|----------|----------|----------|----------|----------|--|--|--|
| Contacts Configuration | | | | | | | | |
| Rated current / voltage | 15A 250V | 15A 250V | 15A 250V | 15A 250V | 10A 250V | | | |
| Operating voltage limit (AC.V.rms) | 400 | 400 | 400 | 400 | 300 | | | |
| Withstanding voltage (AC.V. rms) 1 minute | 2000 | 2000 | 2000 | 1800 | 1800 | | | |
| Insulation resistance (MΩ MIN.) at DC 500V | 2000 | 2000 | 2000 | 2000 | 2000 | | | |
| Contact resistance (mΩ MAX.) at DC 1A | 3 | 3 | 3 | 3 | 3 | | | |
| Solder internal diameter | 2.8 | 2.8 | 2.8 | 2.8 | 2.5 | | | |

Socket Female Contact

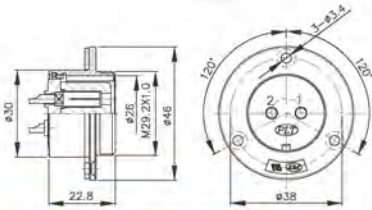

PLT-30-**RF-R**

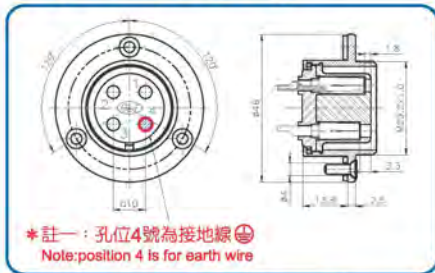

PLT-304E-**RF-R**



PLT-307E-**RF-R**

Adapter Female Contact

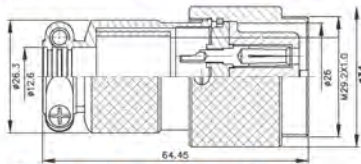

PLT-30-**ADF-R**

Plug Male Contact



另有鎖側螺絲選項
Optional accessory: side screws

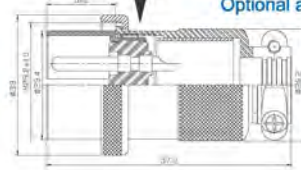

PLT-30-**PM-R**

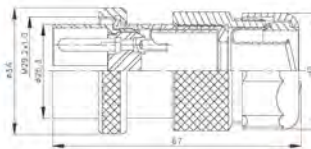

軟管 / Conduit

| | | | |
|---|---------|-------|-------|
| 3 | 3/8" 軟管 | d1 | d2 |
| | | Ø10.8 | Ø26.3 |
| 4 | 1/2" 軟管 | d1 | d2 |
| | | Ø14.3 | Ø31.2 |

PLT-30-**GPM-R**

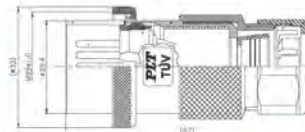

尼龍管 / Nylon Tube

| | | | |
|---|---------|-------|-------|
| 3 | 3/8" 軟管 | d1 | d2 |
| | | Ø10.8 | Ø26.3 |
| 4 | 1/2" 軟管 | d1 | d2 |
| | | Ø14.3 | Ø31.2 |

PLT-30-**WGPM-R**

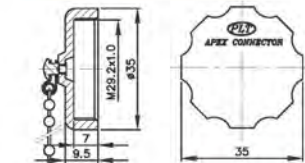
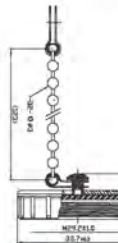

Material: Plastic
材質: 塑膠

Material: Zinc Alloy
材質: 鋅合金



PLT-30A-**RCa-R**



Material: Plastic
材質: 塑膠

PAT A-591PX



PLT-30C-**RCa-R**

| No. of contacts | 2 | 3 | 4 | 5 | 7 | 8 | | |
|--|--------------|--------------|--------------|--------------|--------------|--------------|--|--|
| Contacts Configuration | | | | | | | | |
| Rated current / voltage | TÜV 15A 250V | TÜV 15A 250V | TÜV 15A 250V | TÜV 15A 250V | TÜV 15A 250V | TÜV 10A 250V | | |
| Operating voltage limit (AC.V.rms) | 400 | 400 | 400 | 400 | 400 | 300 | | |
| Withstanding voltage (AC.V. rms) 1 minute | 2000 | 2000 | 2000 | 1800 | 1800 | 1800 | | |
| Insulation resistance (MΩ MIN.) at DC 500V | 2000 | 2000 | 2000 | 2000 | 2000 | 2000 | | |
| Contact resistance (mΩ MAX.) at DC 1A | 3 | 3 | 3 | 3 | 3 | 3 | | |
| Solder internal diameter | 2.8 | 2.8 | 2.8 | 2.8 | 2 | 2.5 | | |

30

PLT-30 Series

Socket male Contact

Plug Female Contact

2
PLT SERIES

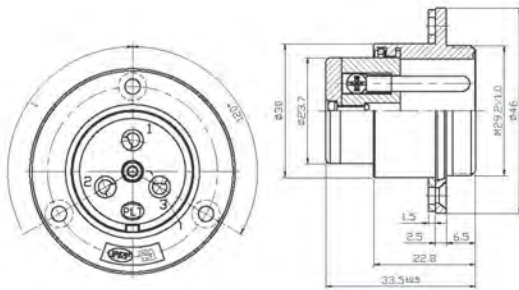

PLT-303-RN-R



●另有鎖側螺絲選項
Optional accessory: side screws

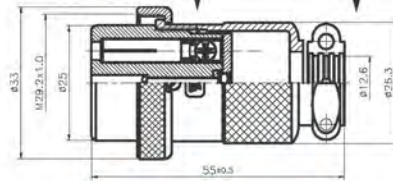
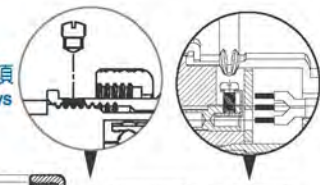

PLT-303-PN-R

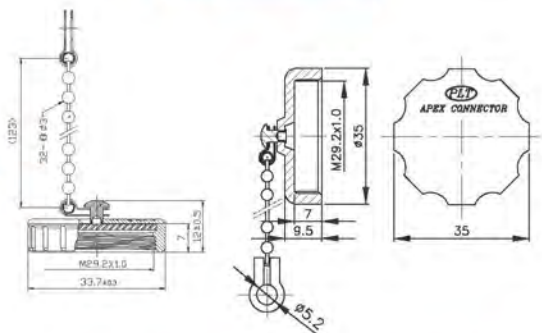

Screw-Lockup-Contact Model

螺絲鎖附型

Patent of invention, all rights reserved

專利產品，仿冒必究



Material: Plastic
材質: 塑膠

PAT A-591PX

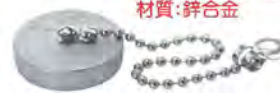

Material: Zinc Alloy
材質: 鋅合金

Material: Plastic
材質: 塑膠

PLT-30C-RCa-R

PLT-30A-RCa-R

| | | | | | | | | |
|--|----------|--|--|--|--|--|--|--|
| No. of contacts | 3 | | | | | | | |
| Contacts Configuration | TÜV | | | | | | | |
| Rated current / voltage | 15A 250V | | | | | | | |
| Operating voltage limit (AC.V.rms) | 400 | | | | | | | |
| Withstanding voltage (AC.V. rms) 1 minute | 2000 | | | | | | | |
| Insulation resistance (MΩ MIN.) at DC 500V | 2000 | | | | | | | |
| Contact resistance (mΩ MAX.) at DC 1A | 3 | | | | | | | |
| Solder internal diameter | 2.8 | | | | | | | |

Socket Male Contact



Plug Female Contact

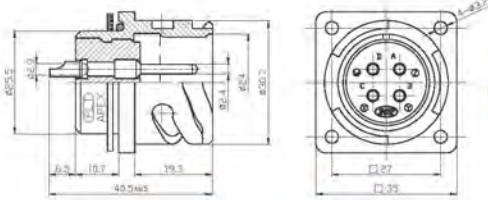

PLT3102A 18-10PA

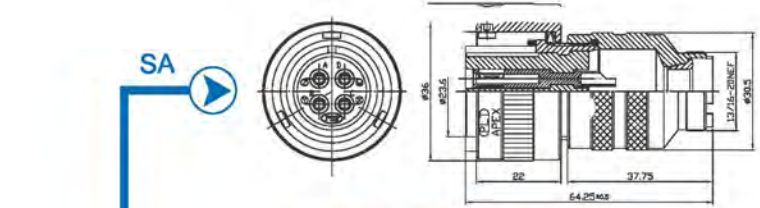

PLT3106A 18-10SA

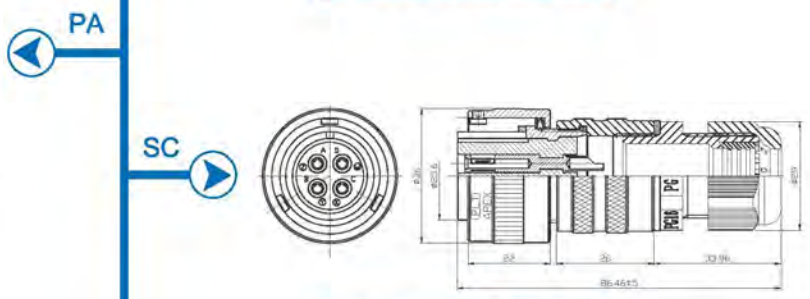

PLT3106A 18-10SC



PLT-18RCa

Material: Aluminum Alloy
材質: 鋁合金

| | | | |
|--|------------------------|--|--|
| No. of contacts | 4 | | |
| Contacts Configuration | | | |
| Operating voltage | 23A DC:700V AC:500V | | |
| Withstanding voltage (AC.V. rms) 1 minute | 2000 | | |
| Insulation resistance (MΩ MIN.) at DC 500V | 5000 | | |
| Test Current | 23 | | |

Socket male Contact

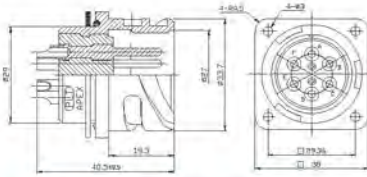

PLT3102A 20-15PA

Plug Female Contact

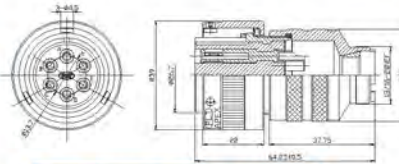

PLT3106A 20-15SA

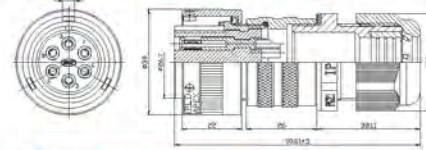

PLT3106A 20-15SC

PLT-20RCa

Material: Aluminum Alloy
材質: 鋁合金



Plug male Contact

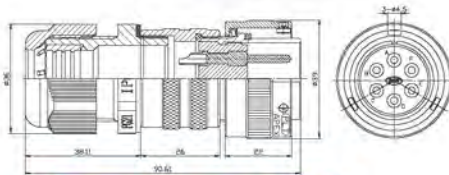

PLT3106A 20-15PC

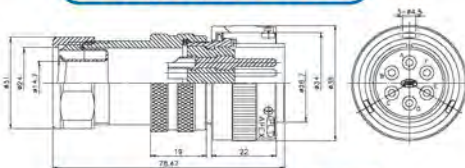

PLT3106A 20-15PG4

Socket Female Contact

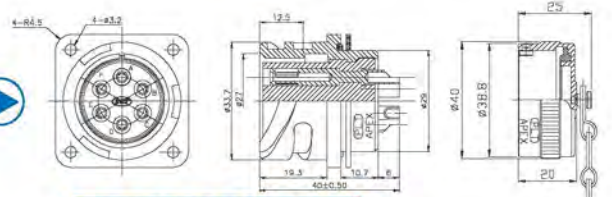

PLT3102A 20-15SA

PLT-20RCa

Material: Aluminum Alloy
材質: 鋁合金



| | | | |
|--|---|--|--|
| No. of contacts | 6 | | |
| Contacts Configuration |  | | |
| Operating voltage | 23A DC:700V AC:500V | | |
| Withstanding voltage (AC.V. rms) 1 minute | 2000 | | |
| Insulation resistance (MQ MIN.) at DC 500V | 5000 | | |
| Test Current | 23 | | |



Plug Female Contact

Socket Male Contact

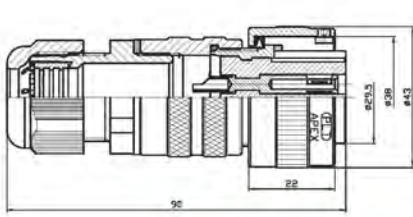

PLT3106A 22-22SC

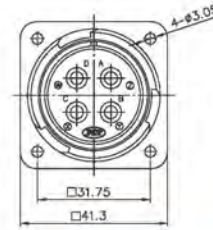
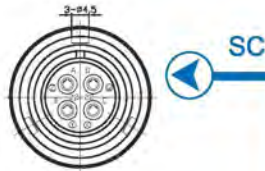

PLT3102A 22-22PA

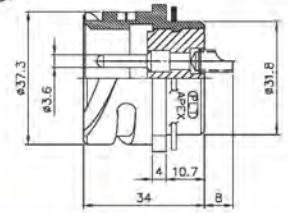

Material: Aluminum Alloy
材質: 鋁合金

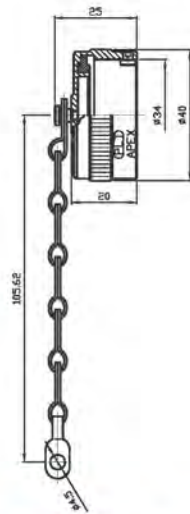

PLT-22RCa



| | | | | |
|--|-------------------------|--|--|--|
| No. of contacts | 4 | | | |
| Contacts Configuration | | | | |
| Operating voltage | 46A DC:1250V AC:900V | | | |
| Withstanding voltage (AC.V. rms) 1 minute | 2000 | | | |
| Insulation resistance (MΩ MIN.) at DC 500V | 5000 | | | |
| Test Current | 46 | | | |

32

PLT-32 Series

Plug Female Contact



Socket Male Contact

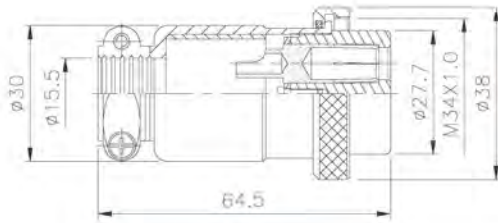

PLT-32-P-R

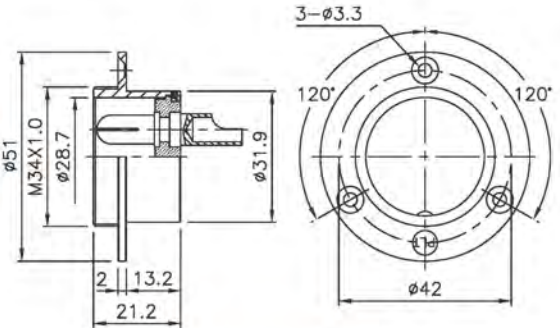

PLT-32-R-R

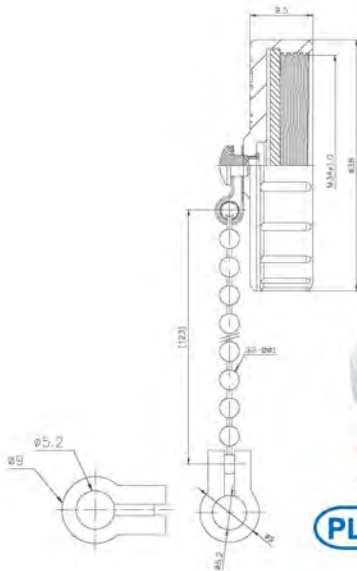
Material: Zinc Alloy
材質: 鋅合金

PLT-32C-RCaN-R

Finish (表面處理) → [Nickel-plated / 鍍鎳
Chrome-plated / 鍍鉻

| ◆ No. of contacts | 2 | 3 | | | | | | |
|--|--------------|--------------|--|--|--|--|--|--|
| Contacts Configuration | | | | | | | | |
| Rated current / voltage | TÜV 30A 250V | TÜV 30A 250V | | | | | | |
| Operating voltage limit (AC.V.rms) | 400 | 400 | | | | | | |
| Withstanding voltage (AC.V. rms) 1 minute | 2000 | 2000 | | | | | | |
| Insulation resistance (MΩ MIN.) at DC 500V | 2000 | 2000 | | | | | | |
| Contact resistance (mΩ MAX.) at DC 1A | 5 | 5 | | | | | | |
| Solder internal diameter | 6 | 6 | | | | | | |

Plug Female Contact

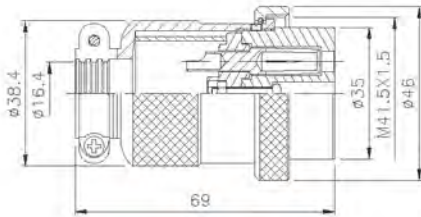

PLT-40◆-P-R

Socket Male Contact

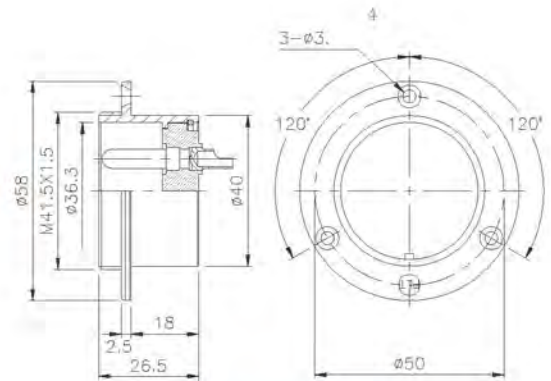

PLT-40◆-R-R

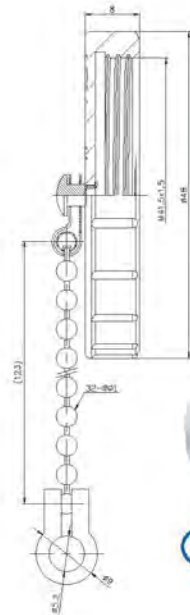

PLT-40C-RCaC-R Material: Zinc Alloy 材質: 鋅合金

| ◆ No. of contacts | 4 | 8 | 37 | | | | |
|--|--------------|--------------|-------------|--|--|--|--|
| Contacts Configuration | | | | | | | |
| Rated current / voltage | TÜV 30A 250V | TÜV 20A 250V | TÜV 5A 300V | | | | |
| Operating voltage limit (AC.V.rms) | 500 | 400 | 300 | | | | |
| Withstanding voltage (AC.V. rms) 1 minute | 2500 | 2000 | 1000 | | | | |
| Insulation resistance (MΩ MIN.) at DC 500V | 2000 | 2000 | 1800 | | | | |
| Contact resistance (mΩ MAX.) at DC 1A | 3 | 3 | 3 | | | | |
| Solder internal diameter | 4 | 4.8 | 1.9 | | | | |

40

PLT-40 Series

Plug male Contact

Socket Female Contact

2
PLT SERIES

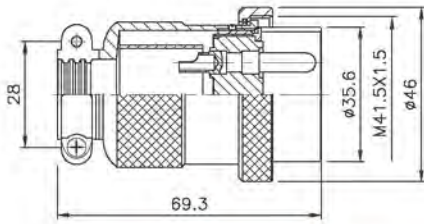

PLT-40-PM-R

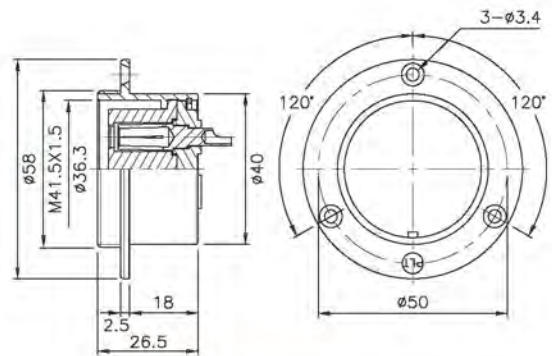

PLT-40-RF-R

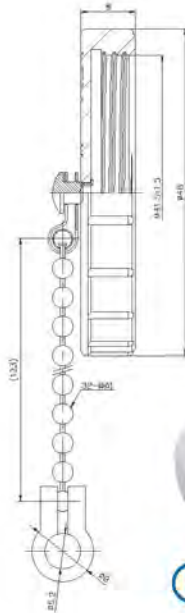

PLT-40C-RCaC-R

Material: Zinc Alloy
材質: 鋅合金

| | | | | | | | |
|---|--------------|-------------|--|--|--|--|--|
| No. of contacts | 4 | 37 | | | | | |
| Contacts Configuration | | | | | | | |
| Rated current / voltage | TÜV 30A 250V | TÜV 5A 300V | | | | | |
| Operating voltage limit (AC.V.rms) | 500 | 200 | | | | | |
| Withstanding voltage (AC.V. rms) 1 minute | 2500 | 1000 | | | | | |
| Insulation resistance (MΩ MIN.) at DC 500V | 2000 | 1800 | | | | | |
| Contact resistance (mΩ MAX.) at DC 1A | 3 | 3 | | | | | |
| Solder internal diameter | 4 | 1.9 | | | | | |

Plug Female Contact

Socket Male Contact

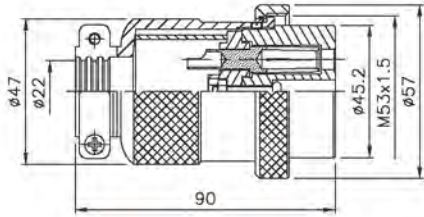

PLT-50◆-P

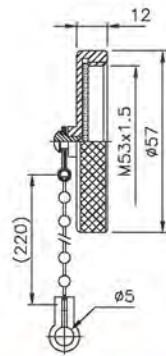

PLT-50-RCa

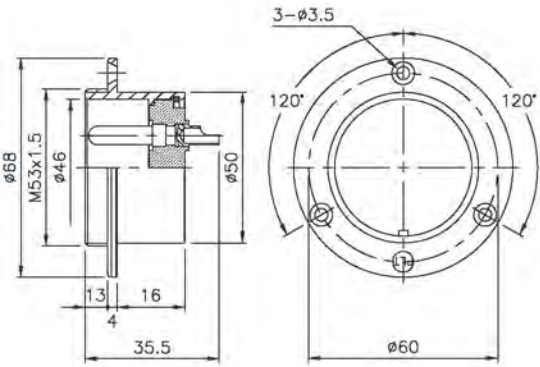

PLT-50◆-R

| | | | | | | | |
|--|---|--|--|--|--|--|--|
| ◆ No. of contacts | 4 | | | | | | |
| Contacts Configuration |  | | | | | | |
| Rated current / voltage | 80A 250V | | | | | | |
| Operating voltage limit (AC.V.rms) | 600 | | | | | | |
| Withstanding voltage (AC.V. rms) 1 minute | 3000 | | | | | | |
| Insulation resistance (MΩ MIN.) at DC 500V | 5000 | | | | | | |
| Contact resistance (mΩ MAX.) at DC 1A | 3 | | | | | | |
| Solder internal diameter | | | | | | | |



PLS-20 Series



PLS-24 Series



PLS-27 Series



PLS-28 Series



Stainless Steel 不鏽鋼

PLS-28 Series



PLS-35 Series



PLS-41 Series



PLS-4207 Series



WGP

防水電氣尼龍配管
Waterproof Corrugated Nylon Tube



GP

防水防爆電氣配管
Waterproof Explosionproof Tube
with Steel Wire Braiding



CG

耐扭試電纜固定頭
Flex Protecting Cable Glands

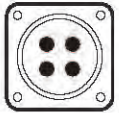

● ORDERING INFORMATION

PLS-202-PM X-R



● 圖一

| | | | | | |
|------------|-------------------|------|-----------|--------------|-----|
| PM | Plug Male | 插頭導針 | AD | Adapter | 中繼 |
| PF | Plug Female | 插頭導梢 | Ca | Cap | 保護蓋 |
| RM | Receptacle Male | 插座導針 | RT | Rubber tube | 橡膠管 |
| RF | Receptacle Female | 插座導梢 | GP | Conduit type | 軟管式 |
| WGP | Nylon type | 尼龍管式 | CG | Cable glands | 迫緊頭 |

● MATERIAL & FINISH

Kindly refer to the below column for material & finish when ordering

| Description | Material | Finish |
|-----------------|---|--|
| Shell / 外殼、本體 | <ul style="list-style-type: none"> • Stainless Steel / 不鏽鋼 • Zinc alloy Die Casting / 鋅合金壓鑄 • Aluminum alloy Die Casting / 鋁合金壓鑄 | <ul style="list-style-type: none"> • Chrome-plated / 鍍鉻 • Gold-plated / 鍍金 • Nickel-plated / 鍍鎳 • Silver-plated / 鍍銀 |
| Insulator / 絕緣體 | <ul style="list-style-type: none"> • Bakelite / 電木 • Delrin / 塑鋼 • Teflon / 鐵氟龍 | |
| Contact / 接點 | <ul style="list-style-type: none"> • Copper / 銅 • Phosphor Copper / 磷青銅 • Beryllium Copper / 鈹銅 | <ul style="list-style-type: none"> • Gold-plated / 鍍金 • Nickel-plated / 鍍鎳 • Silver-plated / 鍍銀 |

▲ **WARNING** : Electric Shock Hazard, Do Not Hot Plugging.

▲ 警告：為避免觸電，通電狀態下禁止插拔電源線连接器。

▲ 警告：感電の恐れがありますので、通電中に電源コードの挿抜を行わないでください。

Socket Female Contact

Plug Male Contact

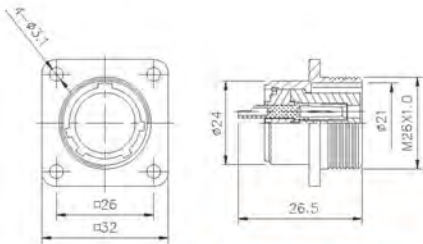

PLS-24 ◆-RF-R

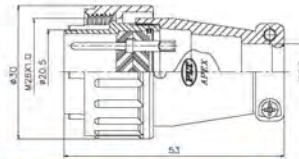

PLS-24 ◆-PM X-R

Adapter Female Contact

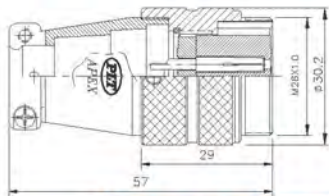

PLS-24 ◆-ADF-R



PLS-24 ◆-PMCG X-R

IP67



PLS-24 ◆-ADGF-R

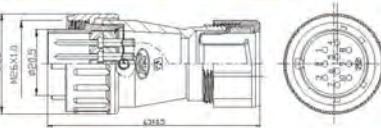

PLS-24 ◆-GPM3 X-R

3=轉接3/8"軟管
Connected with 3/8" conduit

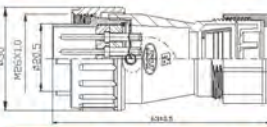

PLS-24 ◆-WGPM3 X-R

3=轉接3/8"尼龍管
Connected with 3/8" nylon tube

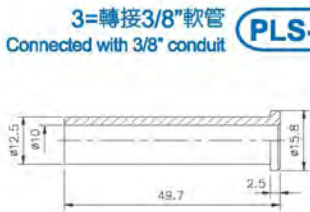

ACCESSORY:
RUBBER TUBE FOR PLS-24 ◆-PM



Material: Plastic
材質: 塑膠

PAT A-588PX

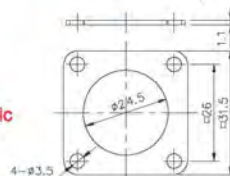

ACCESSORY : RUBBER GASKET FOR PLS-24 ◆-RF

PLS-24C-RCaC-R



Material: Zinc Alloy
材質: 鋅合金

| ◆ No. of contacts | 5 | 10 | | | | | |
|--|----------|----------|--|--|--|--|--|
| Contacts Configuration | | | | | | | |
| Rated current / voltage | 15A 250V | 10A 250V | | | | | |
| Operating voltage limit (AC.V.rms) | 400 | 250 | | | | | |
| Withstanding voltage (AC.V. rms) 1 minute | 1800 | 1000 | | | | | |
| Insulation resistance (MΩ MIN.) at DC 500V | 2000 | 2000 | | | | | |
| Contact resistance (mΩ MAX.) at DC 1A | 3 | 3 | | | | | |
| Solder internal diameter | 2.8 | 1.6 | | | | | |

Plug male Contact

Socket Female Contact

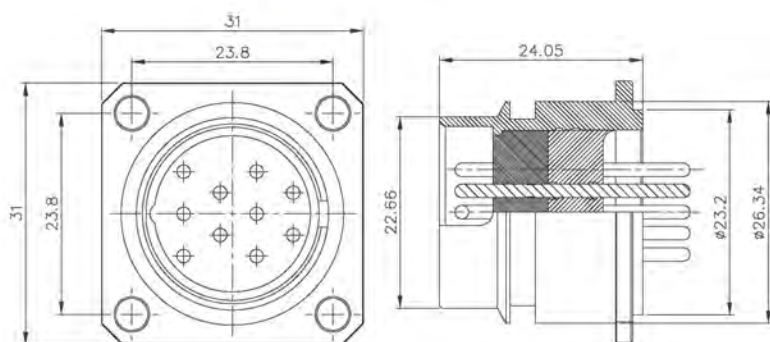

PLS-2710-RM



RM

PF

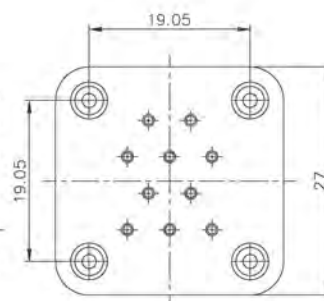
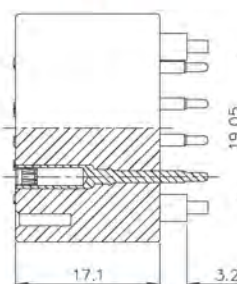
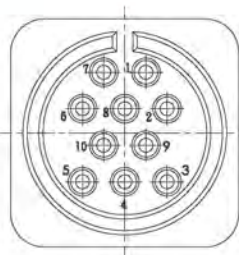

PLS-2710-PF

| | | | | | | | | |
|--|---------|--|--|--|--|--|--|--|
| ◆ No. of contacts | 10 | | | | | | | |
| Contacts Configuration | | | | | | | | |
| Rated current / voltage | 5A 250V | | | | | | | |
| Operating voltage limit (AC.V.rms) | 250 | | | | | | | |
| Withstanding voltage (AC.V. rms) 1 minute | 1000 | | | | | | | |
| Insulation resistance (MΩ MIN.) at DC 500V | 1000 | | | | | | | |
| Contact resistance (mΩ MAX.) at DC 1A | 5 | | | | | | | |
| Solder internal diameter | | | | | | | | |



Socket Male Contact

Plug Female Contact

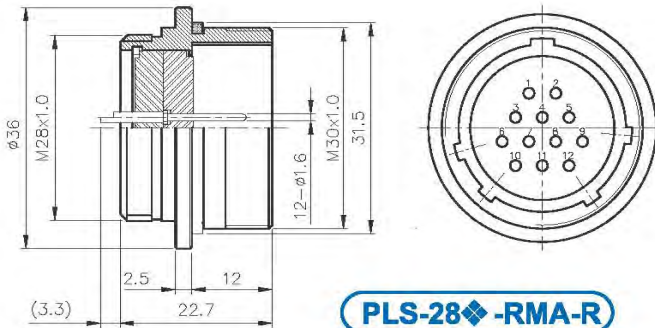

PLS-28-RMA-R

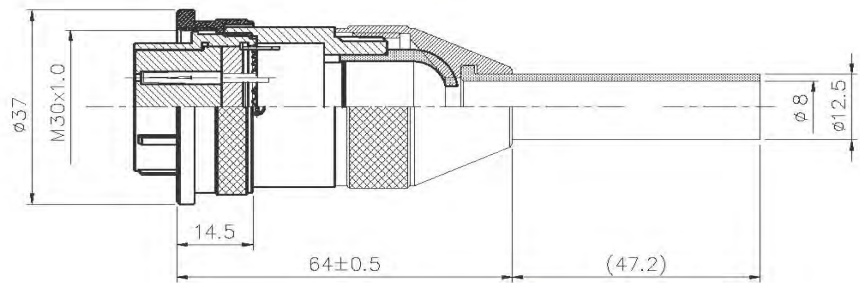

PLS-28-PFA-R

(Stainless Steel 不鏽鋼)

| No. of contacts | 3 | 4 | 7 | 12 | 16 | 17 | 20 | 26 |
|--|--------------|--------------|--------------|--------------|--------------|--------------|-------------|-------------|
| Contacts Configuration | | | | | | | | |
| Rated current / voltage | TÜV 15A 250V | TÜV 15A 250V | TÜV 15A 250V | TÜV 10A 250V | TÜV 10A 250V | TÜV 10A 250V | TÜV 5A 250V | TÜV 5A 250V |
| Operating voltage limit (AC.V.rms) | 400 | 400 | 400 | 250 | 250 | 250 | 250 | 250 |
| Withstanding voltage (AC.V. rms) 1 minute | 2000 | 2000 | 1800 | 1000 | 1000 | 1000 | 1000 | 1000 |
| Insulation resistance (MΩ MIN.) at DC 500V | 2000 | 2000 | 2000 | 1000 | 1000 | 1000 | 1000 | 1000 |
| Contact resistance (mΩ MAX.) at DC 1A | 3 | 3 | 3 | 5 | 5 | 5 | 3 | 3 |
| Solder internal diameter | 3.4 | 3.4 | 2.4 | 1.6 | 1.6 | 1.6 | 1.2 | 1.2 |

Plug Female Contact

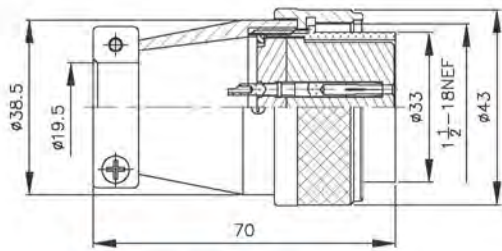

PLS-35◆-PF-R

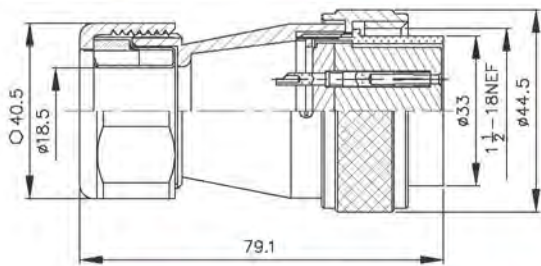
PLS-35◆-GPF6-R 6=轉接3/4"軟管
Connected with 3/4" conduit

AMS25043-24A

Material: Aluminum Alloy
材質: 鋁合金

Socket Male Contact

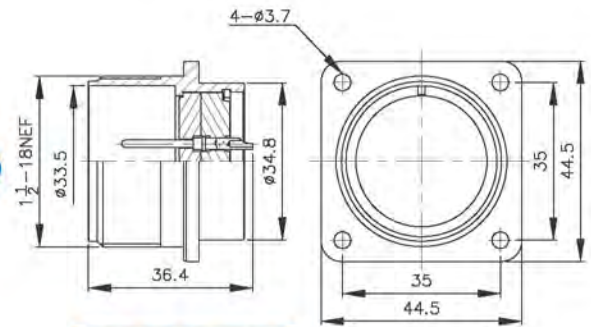

PLS-35◆-RM-R

Adapter Male Contact

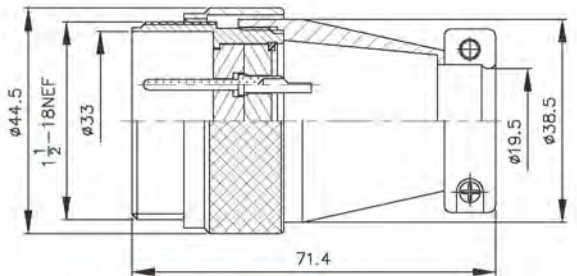

PLS-35◆-ADM-R

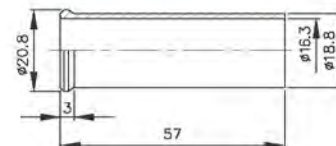

ACCESSORY: RUBBER TUBE FOR PLS-35◆-PF

| | | | | | | | |
|--|---|--|--|--|--|--|--|
| ◆ No. of contacts | 24 | | | | | | |
| Contacts Configuration |  | | | | | | |
| Rated current / voltage | 8A 250V | | | | | | |
| Operating voltage limit (AC.V.rms) | 200 | | | | | | |
| Withstanding voltage (AC.V. rms) 1 minute | 1000 | | | | | | |
| Insulation resistance (MΩ MIN.) at DC 500V | 1000 | | | | | | |
| Contact resistance (mΩ MAX.) at DC 1A | 3 | | | | | | |
| Solder internal diameter | 1.8 | | | | | | |



Socket Female Contact

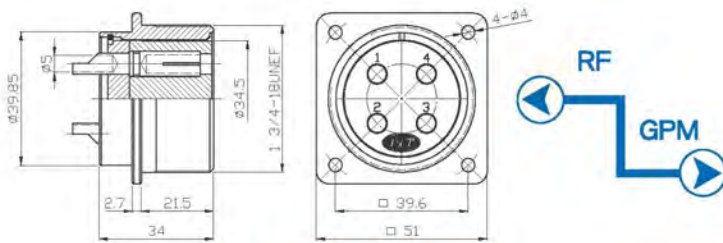

PLS-41 ◆-RF-R

Plug Male Contact

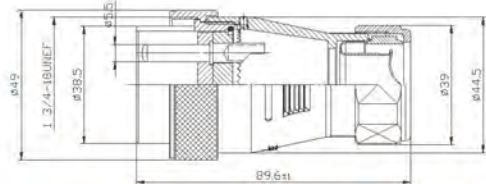

PLS-41 ◆-GPM6-R

6=轉接3/4"軟管
Connected with 3/4" conduit

Plug Female Contact

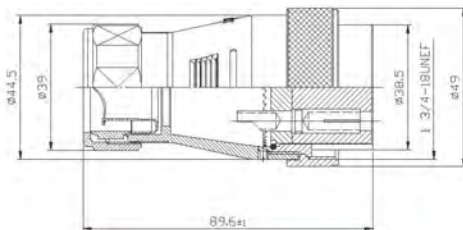

6=轉接3/4"軟管

Connected with 3/4" conduit

PLS-41 ◆-GPF6-R

Socket Male Contact

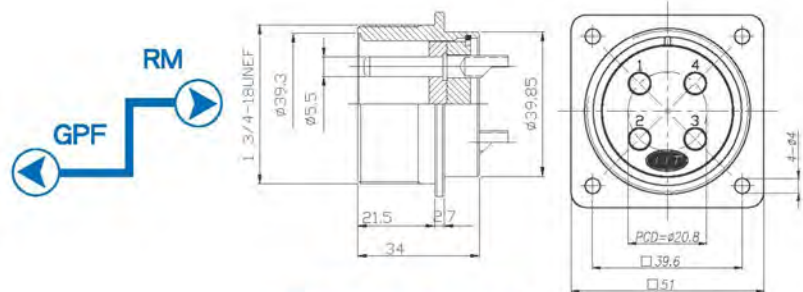

PLS-41 ◆-RM-R

| ◆ No. of contacts | 4 | 8 | | | | | | |
|--|----------|----------|--|--|--|--|--|--|
| Contacts Configuration | | | | | | | | |
| Rated current / voltage | 30A 250V | 15A 250V | | | | | | |
| Operating voltage limit (AC.V.rms) | 500 | 400 | | | | | | |
| Withstanding voltage (AC.V. rms) 1 minute | 2500 | 2000 | | | | | | |
| Insulation resistance (MΩ MIN.) at DC 500V | 2500 | 2000 | | | | | | |
| Contact resistance (mΩ MAX.) at DC 1A | 3 | 3 | | | | | | |
| Solder internal diameter | 5 | 3.5 | | | | | | |



Plug male Contact

Socket Female Contact

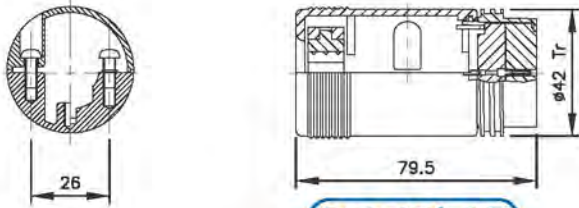

PLS-42 ◆-PF

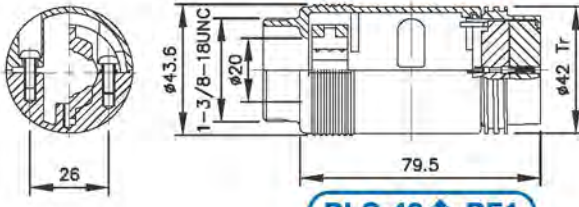

PLS-42 ◆-PF1

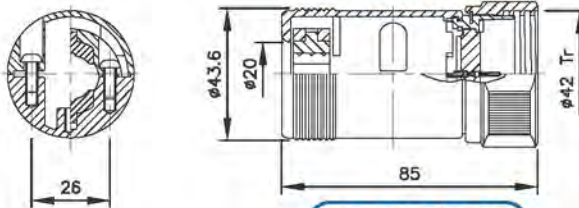

PLS-42 ◆-PM

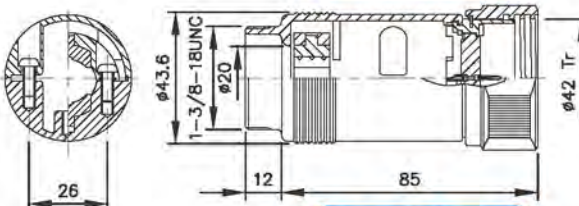

PLS-42 ◆-PM1

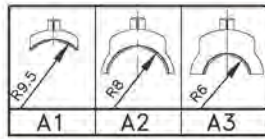

ACCESSORY : Cable clamp

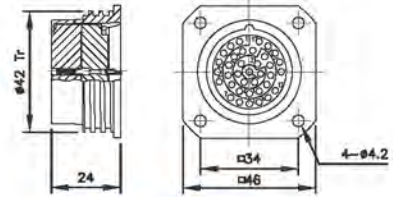

PLS-42 ◆-RF

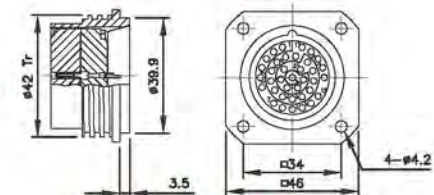

PLS-42 ◆-RF1

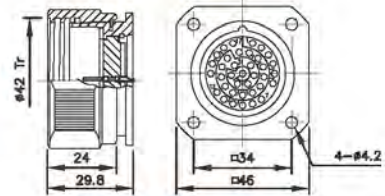

PLS-42 ◆-RM

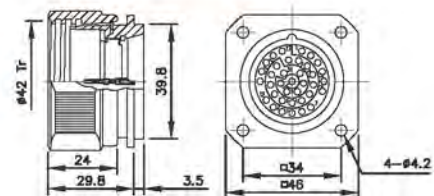

PLS-42 ◆-RM1

| | | | | | | | |
|--|----------|---------|--|--|--|--|--|
| ◆ No. of contacts | 7 | 37 | | | | | |
| Contacts Configuration | | | | | | | |
| Rated current / voltage | 13A 250V | 5A 250V | | | | | |
| Operating voltage limit (AC.V.rms) | 500 | 500 | | | | | |
| Withstanding voltage (AC.V. rms) 1 minute | 2000 | 3000 | | | | | |
| Insulation resistance (MΩ MIN.) at DC 500V | 2000 | 2000 | | | | | |
| Contact resistance (mΩ MAX.) at DC 1A | 3 | 3 | | | | | |
| Solder internal diameter | 3.5 | 1.2 | | | | | |



PLK-16 Series



PLK-16 Series



PLK-30 Series



WGP

防水電氣尼龍配管
Waterproof Corrugated Nylon Tube



GP

防水防爆電氣配管
Waterproof Explosionproof Tube
with Steel Wire Braiding



CG

耐扭試電纜固定頭
Flex Protecting Cable Glands

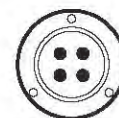

ORDERING INFORMATION



●圖一

| | | | | | |
|------------|-----------------------------|---------|-----------|-------------------|------|
| PM | Plug Male | 插頭導針 | RM | Receptacle Male | 插座導針 |
| PF | Plug Female | 插頭導梢 | RF | Receptacle Female | 插座導梢 |
| P | Plug | 插 頭 | AD | Adapter | 中 繼 |
| R | Receptacle (Front mounting) | 插座(前裝式) | Ca | Cap | 保護蓋 |
| F | Female | 導 梢 | RT | Rubber tube | 橡膠管 |
| M | Male | 導 針 | GP | Conduit type | 軟管式 |
| WGP | Nylon type | 尼龍管式 | CG | Cable glands | 迫緊頭 |

MATERIAL & FINISH

Kindly refer to the below column for material & finish when ordering

| Description | Material | Finish |
|-----------------|---|--|
| Shell / 外殼、本體 | <ul style="list-style-type: none"> • Stainless Steel / 不鏽鋼 • Zinc alloy Die Casting / 鋅合金壓鑄 • Aluminum alloy Die Casting / 鋁合金壓鑄 | <ul style="list-style-type: none"> • Chrome-plated / 鍍鉻 • Gold-plated / 鍍金 • Nickel-plated / 鍍鎳 • Silver-plated / 鍍銀 |
| Insulator / 絕緣體 | <ul style="list-style-type: none"> • Bakelite / 電木 • Delrin / 塑鋼 • Teflon / 鐵氟龍 | / |
| Contact / 接點 | <ul style="list-style-type: none"> • Copper / 銅 • Phosphor Copper / 磷青銅 • Beryllium Copper / 鈹銅 | <ul style="list-style-type: none"> • Gold-plated / 鍍金 • Nickel-plated / 鍍鎳 • Silver-plated / 鍍銀 |

▲WARNING : Electric Shock Hazard, Do Not Hot Plugging.

▲警告：為避免觸電，通電狀態下禁止插拔電源線連接器。

▲警告：感電の恐れがありますので、通電中に電源コードの挿抜を行わないでください。



PLK-16 Series

Socket Male Contact

Plug Female Contact



●另有鎖側螺絲選項
Optional accessory: side screws

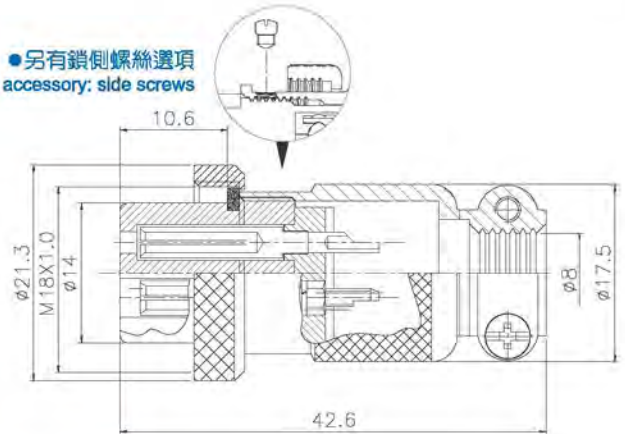
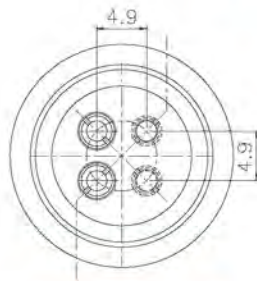

PLK-164-PA-R

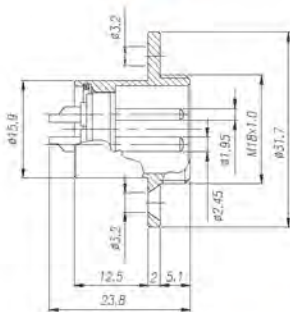
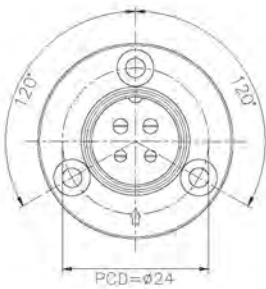
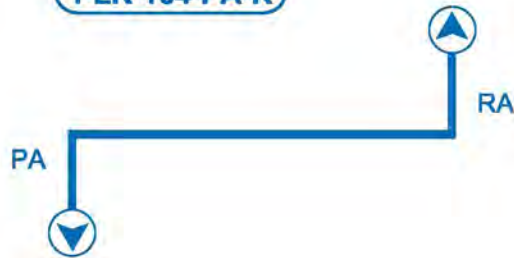

PLK-164-RA-R

| | | | | | | | | |
|--|---------|--|--|--|--|--|--|--|
| ◆ No. of contacts | 4 | | | | | | | |
| Contacts Configuration | | | | | | | | |
| Rated current / voltage | 5A 125V | | | | | | | |
| Operating voltage limit (AC.V.rms) | 200 | | | | | | | |
| Withstanding voltage (AC.V. rms) 1 minute | 1000 | | | | | | | |
| Insulation resistance (MΩ MIN.) at DC 500V | 1000 | | | | | | | |
| Contact resistance (mΩ MAX.) at DC 1A | 3 | | | | | | | |

Plug Female Contact



Socket Male Contact

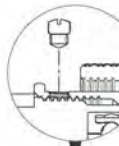

●另有鎖側螺絲選項
Optional accessory: side screws

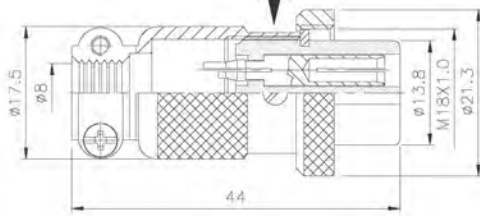

PLK-16◆-P-R

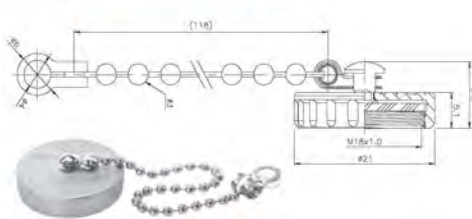

PLK-16C-RCaC-R

Material: Zinc Alloy
材質: 鋅合金

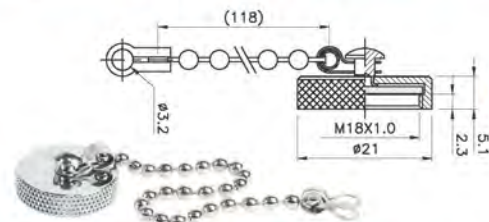

PLK-16-RCa-R

Material: Brass
材質: 銅

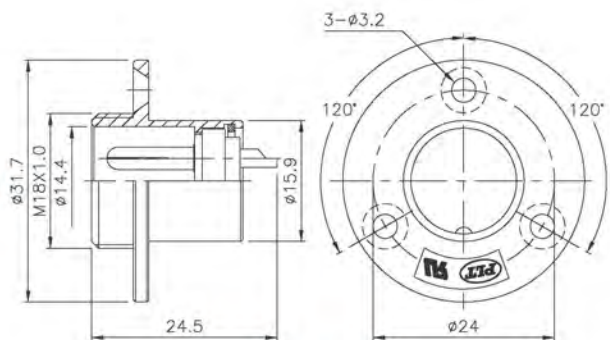

PLK-16◆-R-R

Adapter Male Contact

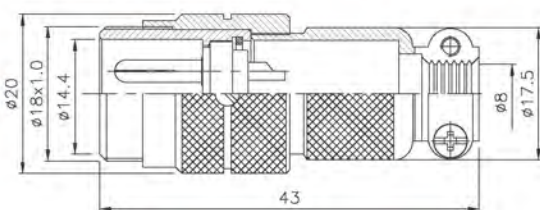

PLK-16◆-AD-R

| ◆ No. of contacts | 2 | 3 | 4 | 5 | | | | |
|--|---------|---------|---------|---------|--|--|--|--|
| Contacts Configuration | | | | | | | | |
| Rated current / voltage | 5A 125V | 5A 125V | 5A 125V | 5A 125V | | | | |
| Operating voltage limit (AC.V.rms) | 200 | 200 | 200 | 200 | | | | |
| Withstanding voltage (AC.V. rms) 1 minute | 1000 | 1000 | 1000 | 1000 | | | | |
| Insulation resistance (MΩ MIN.) at DC 500V | 1000 | 1000 | 1000 | 1000 | | | | |
| Contact resistance (mΩ MAX.) at DC 1A | 3 | 3 | 3 | 3 | | | | |
| Solder internal diameter | 1.5 | 1.5 | 1.5 | 1.3 | | | | |

Plug Male Contact

Socket Female Contact

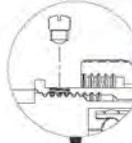

●另有鎖側螺絲選項
Optional accessory: side screws

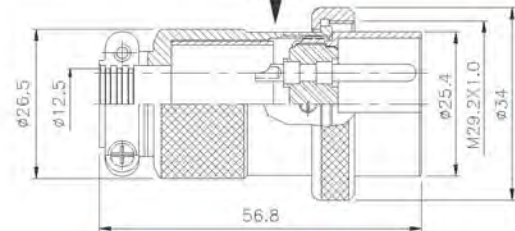

PLK-30-PM-R

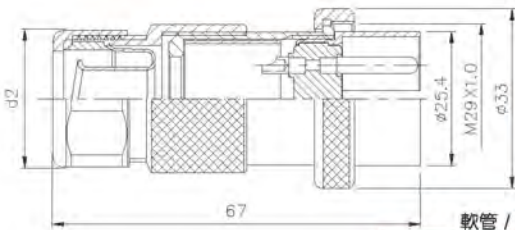

PLK-30-GPM-R

軟管 / Conduit

| | | | |
|---|---------|-------|-------|
| 3 | 3/8" 軟管 | d1 | d2 |
| | | Ø10.8 | Ø26.3 |
| 4 | 1/2" 軟管 | d1 | d2 |
| | | Ø14.3 | Ø31.2 |

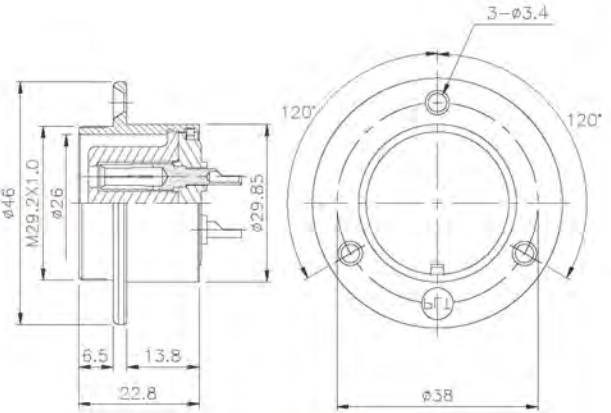

PLK-30-RF-R

MATERIAL: ABS(BLACK)

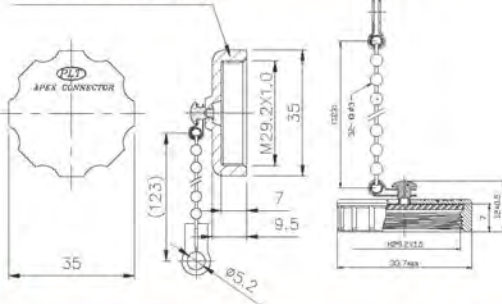

RCa

Material: Plastic
材質: 塑膠



PLT-30A-RCa-R

Material: Zinc Alloy
材質: 鋅合金



PLT-30C-RCa-R

Material: Plastic
材質: 塑膠



PAT A-591PX

| | | | | | | | |
|--|----------|----------|--|--|--|--|--|
| ◆ No. of contacts | 4 | 7 | | | | | |
| Contacts Configuration | | | | | | | |
| Rated current / voltage | 15A 250V | 15A 250V | | | | | |
| Operating voltage limit (AC.V.rms) | 400 | 400 | | | | | |
| Withstanding voltage (AC.V. rms) 1 minute | 2000 | 1800 | | | | | |
| Insulation resistance (MΩ MIN.) at DC 500V | 2000 | 2000 | | | | | |
| Contact resistance (mΩ MAX.) at DC 1A | 3 | 3 | | | | | |
| Solder internal diameter | 3.5 | 3 | | | | | |



WPM16A Series



WPM16C Series



WPM-19 Series



WPM-19 Series



WPM-20 Series



WPM-20 Series



WPM-21 Series



WPM-21 Series



WPM-223 Series



WPM-305A Series



WPM-24 Series



WPM-1814 / WPM-3831



WGP

防水電氣尼龍配管
Waterproof Corrugated Nylon Tube



GP

防水防爆電氣配管
Waterproof Explosionproof Tube
with Steel Wire Braiding



CG

耐扭試電纜固定頭
Flex Protecting Cable Glands



5

WPM SERIES

ORDERING INFORMATION

WPM-202-RM-R



| P:PLUG | R:Receptacle | F:Female | M:Male |
|--------|--------------|----------|--------|
| 插頭 | 插座 | 導梢 | 導針 |

▲WARNING : Electric Shock Hazard, Do Not Hot Plugging.

▲警告 : 為避免觸電, 通電狀態下禁止插拔電源線连接器。

▲警告 : 感電の恐れがありますので、通電中に電源コードの挿抜を行わないでください。



Plug Female Contact

Plug Male Contact



WPM SERIES 5

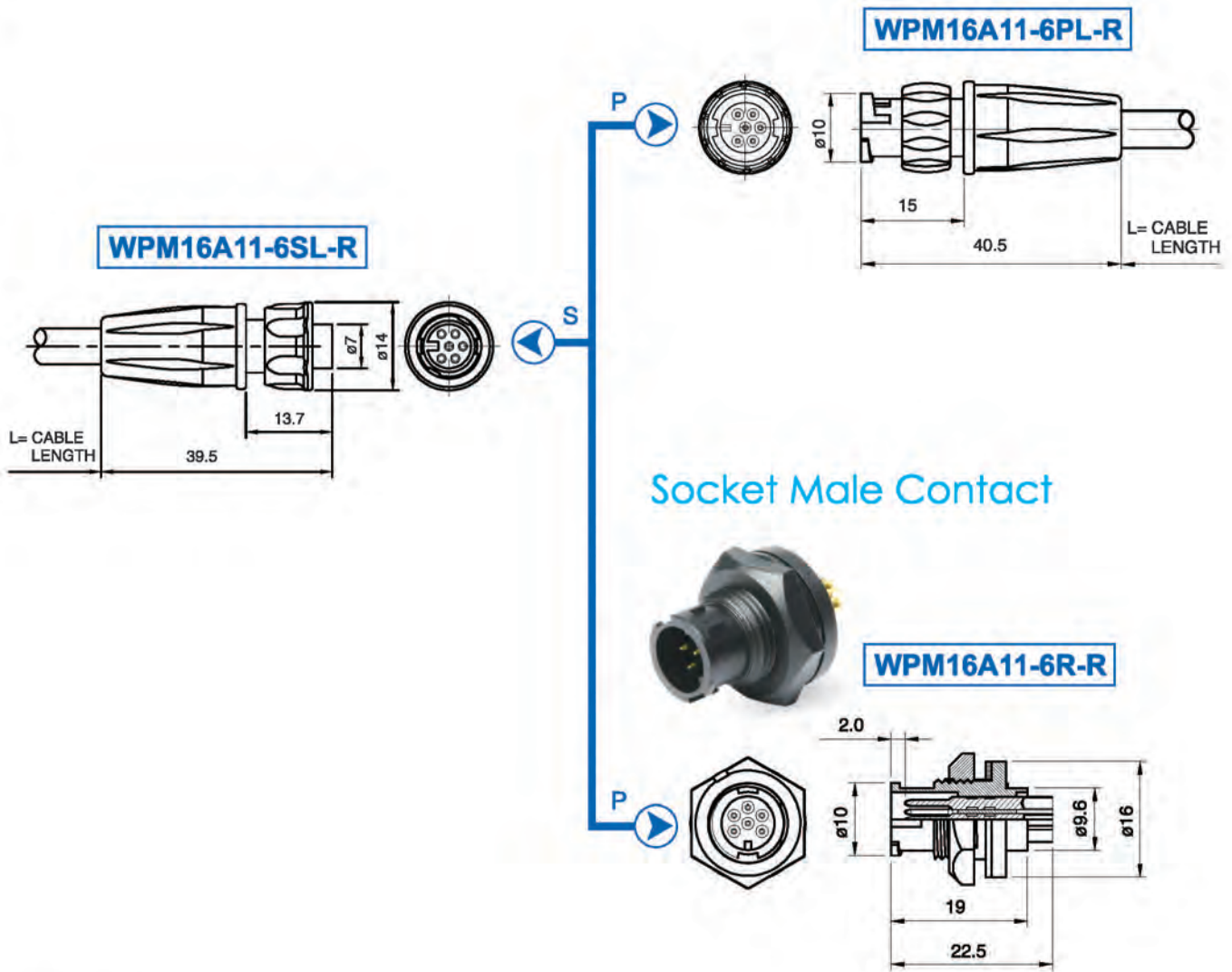

| | | | | | | |
|--|---------|--|--|--|--|--|
| No. of contacts | 6 | | | | | |
| Contacts Configuration | | | | | | |
| Rated voltage | 125V AC | | | | | |
| Rated current | 3A | | | | | |
| Insulation resistance (MΩ MIN.) at DC 500V | 100 | | | | | |
| Withstanding voltage (AC.V. rms) 1 minute | 300 | | | | | |

Plug Female Contact

Plug Male Contact



WPM16C12-4S-R

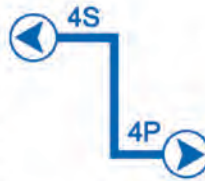
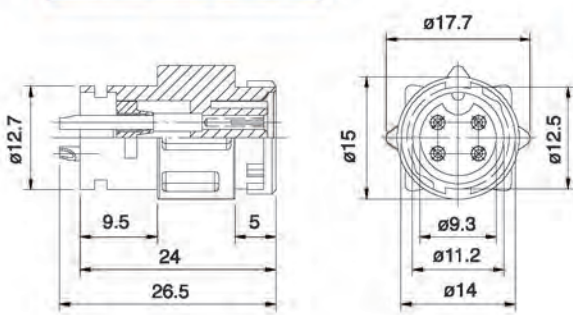

WPM16C12-4P-R

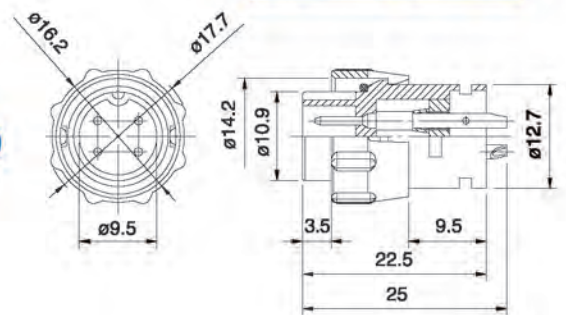

WPM16C12-8S-R

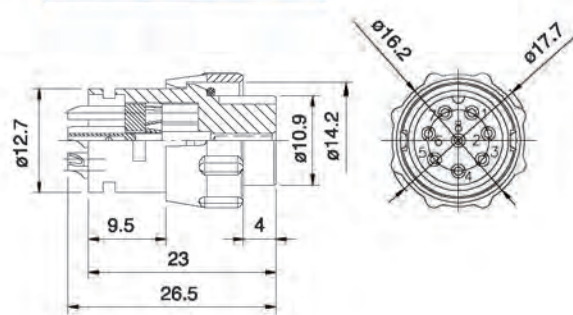

WPM16C12-8P-R

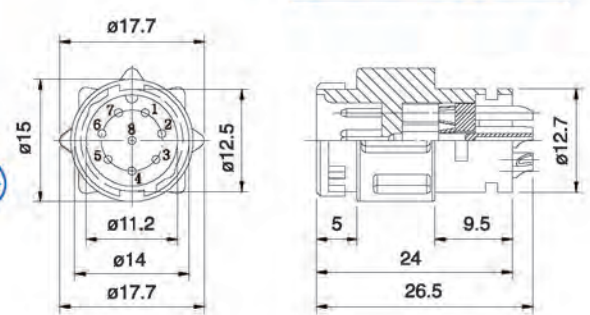

5 WPM SERIES

| ◆ No. of contacts | 4 | 8 | | | | |
|--|---------|---------|--|--|--|--|
| Contacts Configuration | | | | | | |
| Rated voltage | 125V AC | 125V AC | | | | |
| Rated current | 3A | 3A | | | | |
| Withstanding voltage (AC.V. rms) 1 minute | 1000 | 1000 | | | | |
| Insulation resistance (MΩ MIN.) at DC 500V | 100 | 100 | | | | |
| Contact resistance (mΩ MAX.) at DC 1A | 3 | 3 | | | | |



Socket Male Contact

Plug Female Contact



WPM SERIES 5

WPM-19-**RM-R**

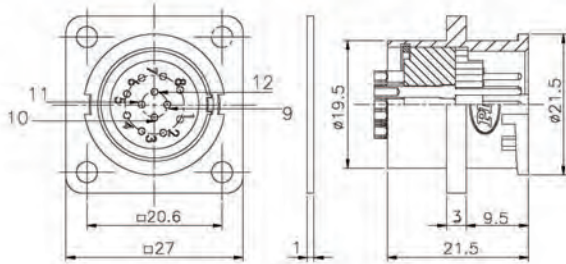

WPM-19-**SPF-R**

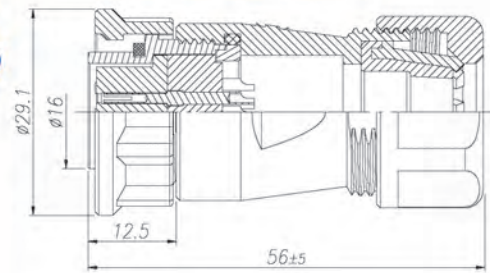

WPM-19-**PF-R**

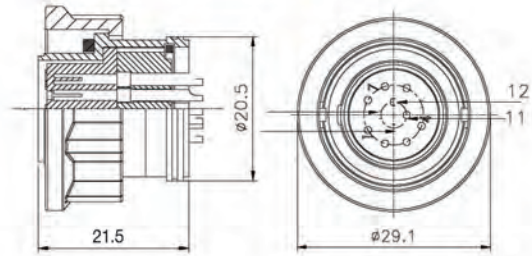

WPM-19-**RCa-R**

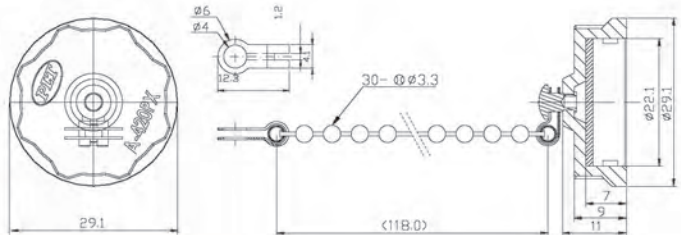

| | | | | | | |
|---|---------|---------|--|--|--|--|
| No. of contacts | 8 | 12 | | | | |
| Contacts Configuration | | | | | | |
| Rated voltage | 125V AC | 125V AC | | | | |
| Rated current | 5A | 5A | | | | |
| Operating voltage limit (AC.V.rms) | 125 | 125 | | | | |
| Withstanding voltage (AC.V. rms) 1 minute | 300 | 300 | | | | |
| Insulation resistance (MΩ MIN.) at DC 500V | 100 | 100 | | | | |
| Contact resistance (mΩ MAX.) at DC 1A | 10 | 10 | | | | |
| Solder internal diameter | 1.2 | 1.2 | | | | |



Waterproof Connector



Socket Female Contact

Plug Male Contact



5
WPM SERIES

WPM-19◆-RF-R

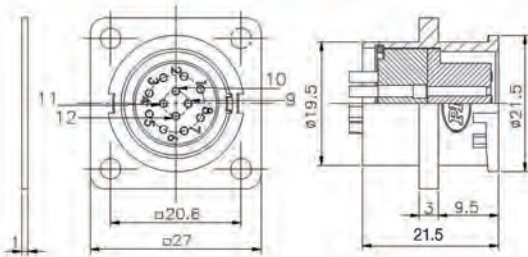

WPM-19◆-SPM-R

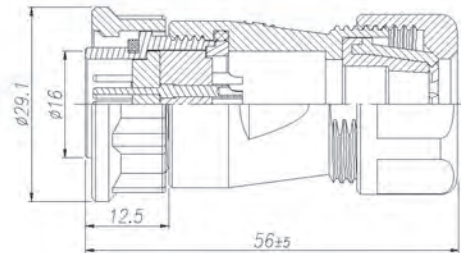

WPM-19◆-PM-R

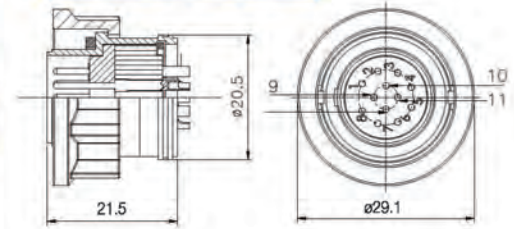

WPM-19◆-RCa-R

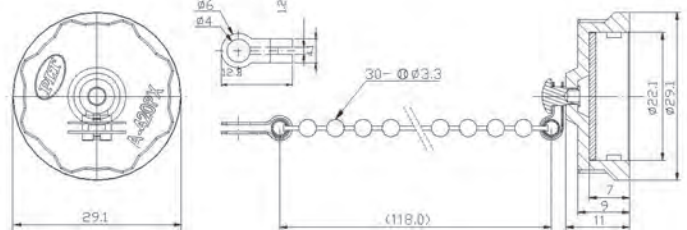

| ◆ No. of contacts | 8 | 12 | | | |
|--|---------|---------|--|--|--|
| Contacts Configuration | | | | | |
| Rated voltage | 125V AC | 125V AC | | | |
| Rated current | 5A | 5A | | | |
| Operating voltage limit (AC.V.rms) | 125 | 125 | | | |
| Withstanding voltage (AC.V. rms) 1 minute | 300 | 300 | | | |
| Insulation resistance (MΩ MIN.) at DC 500V | 100 | 100 | | | |
| Contact resistance (mΩ MAX.) at DC 1A | 10 | 10 | | | |
| Solder internal diameter | 1.2 | 1.2 | | | |



Plug Female Contact

Socket Male Contact



WPM SERIES 5

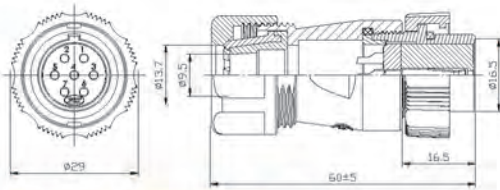

WPM-20-SPF-R

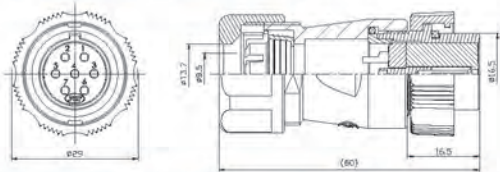

WPM-20-WSPF2.5-R 2.5=轉接5/16"尼龍管
Connected with 5/16" nylon tube

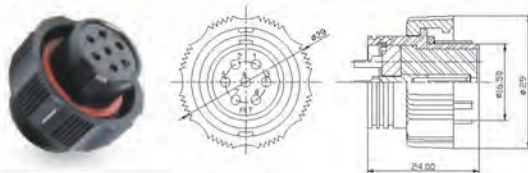

WPM-20-PF-R



WPM-20-RCa-R

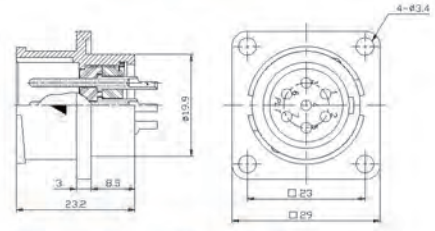
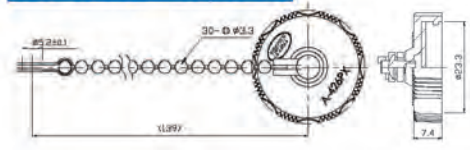

WPM-20-RM-R

Adapter Male Contact

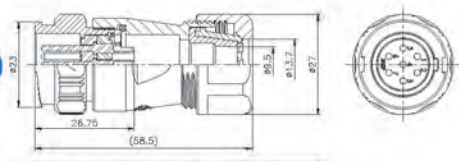

WPM-20-ADM-R

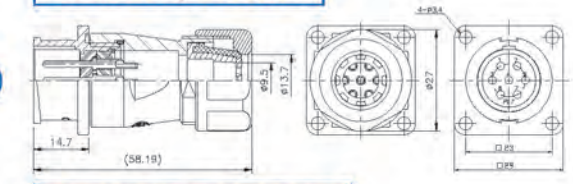

WPM-20-ADMA-R

| No. of contacts | 2 | 3 | 4 | 5 | 7 | 12 |
|--|---------|---------|---------|---------|---------|---------|
| Contacts Configuration | | | | | | |
| Rated voltage | 250V AC | 250V AC | 250V AC | 250V AC | 250V AC | 250V AC |
| Rated current | 15A | 15A | 15A | 15A | 10A | 5A |
| Operating voltage limit (AC.V.rms) | 250 | 250 | 250 | 250 | 250 | 250 |
| Withstanding voltage (AC.V. rms) 1 minute | 1500 | 1500 | 1500 | 1500 | 1500 | 1000 |
| Insulation resistance (MΩ MIN.) at DC 500V | 2000 | 2000 | 2000 | 2000 | 2000 | 1000 |
| Contact resistance (mΩ MAX.) at DC 1A | 3 | 3 | 3 | <5 | 3 | 5 |
| Solder internal diameter | 1.8 | 1.8 | 1.6 | 1.6 | 1.6 | 1.2 |



Plug Male Contact

Socket Female Contact

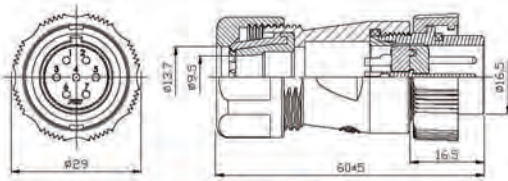

WPM-20-SPM-R

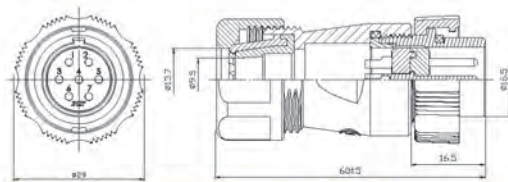

WPM-20-WSPM2.5-R 2.5=轉接5/16"尼龍管
Connected with 5/16" nylon tube



WPM-20-PM-R

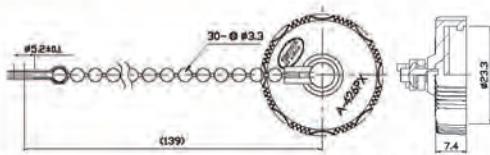

WPM-20-RCa-R

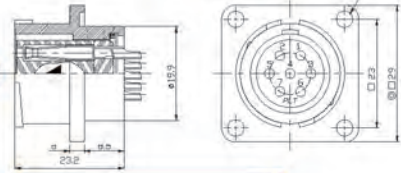

WPM-20-RF-R

Plug Female Contact

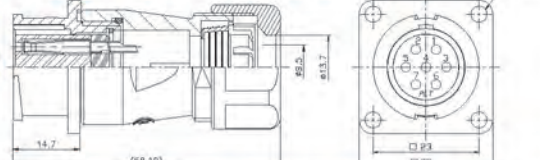

WPM-20-WGPF2.5-R 2.5=轉接5/16"尼龍管
Connected with 5/16" nylon tube

Adapter Female Contact

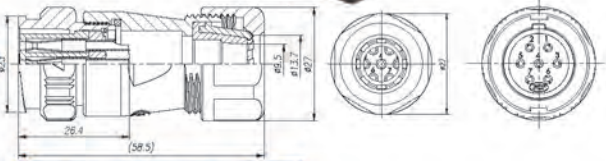

WPM-20-ADF-R

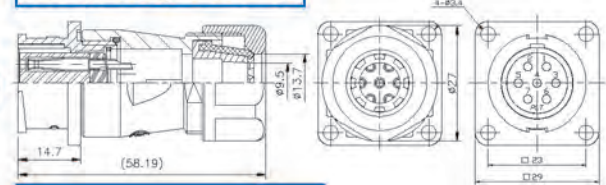

WPM-20-ADFA-R

| ◆ No. of contacts | 2 | 3 | 4 | 5 | 7 | 12 |
|--|---------|---------|---------|---------|---------|---------|
| Contacts Configuration | | | | | | |
| Rated voltage | 250V AC | 250V AC | 250V AC | 250V AC | 250V AC | 250V AC |
| Rated current | 15A | 15A | 15A | 15A | 10A | 5A |
| Operating voltage limit (AC.V.rms) | 250 | 250 | 250 | 250 | 250 | 250 |
| Withstanding voltage (AC.V. rms) 1 minute | 1500 | 1500 | 1500 | 1500 | 1500 | 1000 |
| Insulation resistance (MΩ MIN.) at DC 500V | 2000 | 2000 | 2000 | 2000 | 2000 | 1000 |
| Contact resistance (mΩ MAX.) at DC 1A | 3 | 3 | 5 | <5 | 3 | 5 |
| Solder internal diameter | 1.8 | 1.8 | 1.6 | 1.6 | 1.6 | 1.2 |

5 WPM SERIES



Socket Female Contact

Plug Male Contact



WPM SERIES 5

WPM-21-**RF-R**

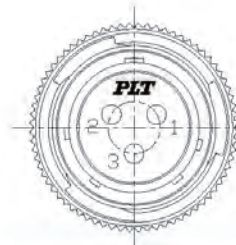
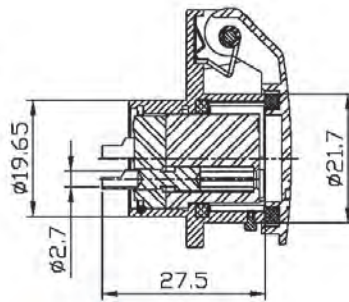
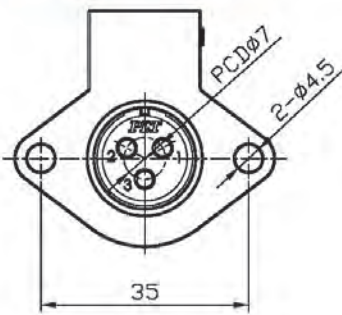

WPM-21-**PM-R**

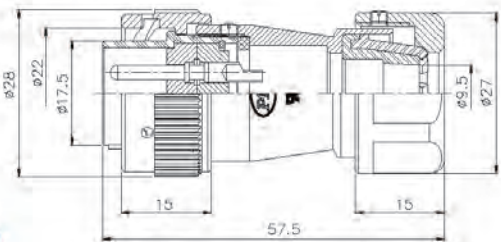

| | | | | | |
|--|---------|--|--|--|--|
| No. of contacts | 3 | | | | |
| Contacts Configuration | | | | | |
| Rated voltage | 250V AC | | | | |
| Rated current | 15A | | | | |
| Operating voltage limit (AC.V.rms) | 250 | | | | |
| Withstanding voltage (AC.V. rms) 1 minute | 1500 | | | | |
| Insulation resistance (MΩ MIN.) at DC 500V | 2000 | | | | |
| Contact resistance (mΩ MAX.) at DC 1A | 3 | | | | |

Plug Female Contact

Socket Male Contact

Cable Glands



Cable Clamp



SHELL: STAINLESS STEEL
(不鏽鋼)

5
WPM SERIES

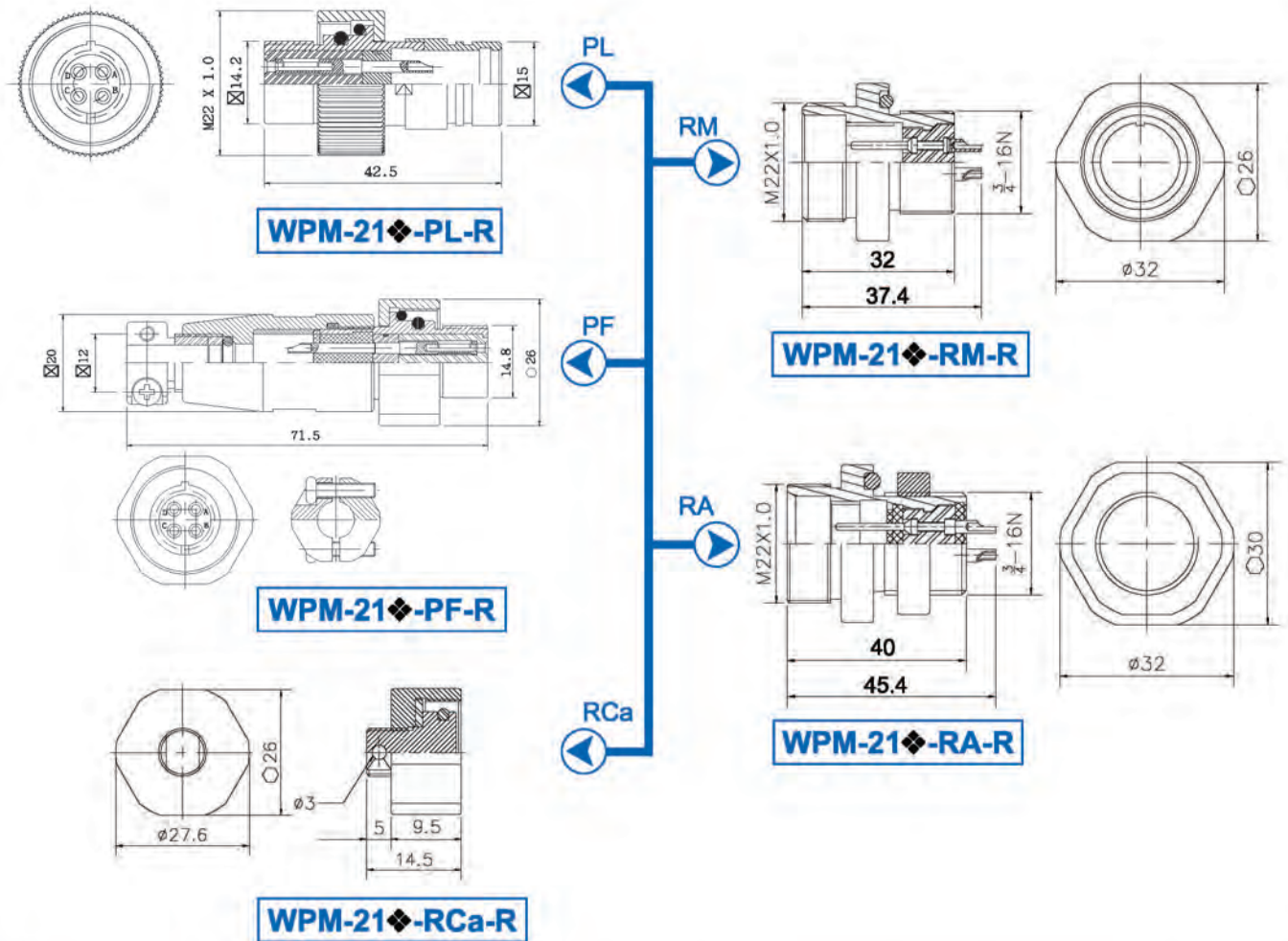

| | | | | | | |
|--|---------|--|--|--|--|--|
| ◆ No. of contacts | 4 | | | | | |
| Contacts Configuration | | | | | | |
| Rated voltage | 250V AC | | | | | |
| Rated current | 15A | | | | | |
| Operating voltage limit (AC.V.rms) | 250 | | | | | |
| Insulation resistance (MΩ MIN.) at DC 500V | 1500 | | | | | |
| Contact resistance (mΩ MAX.) at DC 1A | 3 | | | | | |
| Solder internal diameter | 1.5 | | | | | |



Plug Male Contact

Socket Female Contact

WPM SERIES 5

WPM-223-PM-R

WPM-223-RF-R



| No. Electrical Specification | |
|------------------------------|--|
| 1 | Insulation resistance (MΩ MIN.) at DC 500V ≧ 100MΩ at DC500V |
| 2 | Withstanding voltage (AC.V.rms) 1 minute ≧ AC600V / 1 Minute |

WPM-223-PMA-R

WPM-223-RFA-R



| No. Electrical Specification | |
|------------------------------|--|
| 1 | Insulation resistance (MΩ MIN.) at DC 500V ≧ 100MΩ at DC500V |
| 2 | Withstanding voltage (AC.V.rms) 1 minute ≧ AC300V / 1 Minute |

| | | | | | |
|--|---------|--|--|--|--|
| No. of contacts | 3 | | | | |
| Contacts Configuration | | | | | |
| Rated voltage | 600V AC | | | | |
| Rated current | 23A | | | | |
| Withstanding voltage (AC.V. rms) 1 minute | 2000 | | | | |
| Insulation resistance (MΩ MIN.) at DC 500V | 5000 | | | | |
| Contact resistance (mΩ MAX.) at DC 1A | 3 | | | | |



Waterproof Connector



Socket Male Contact

Plug Female Contact

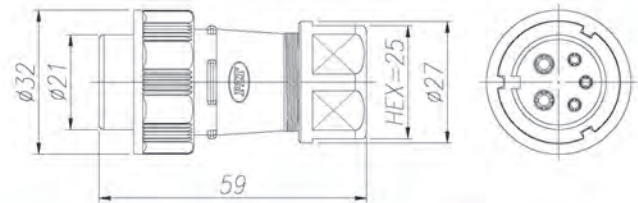
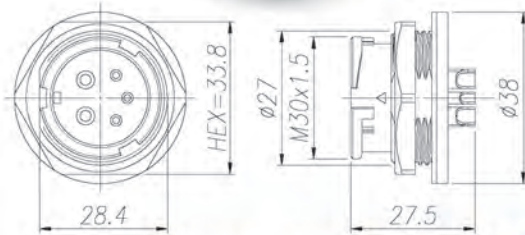

WPM-305A-RM-R

RM

PF

WPM-305A-PF-R

| | |
|--|----------|
| No. of contacts | 5 |
| Contacts Configuration | |
| Rated voltage | 250V AC |
| Rated current | 5A / 20A |
| Operating voltage limit (AC.V.rms) | 250 |
| Withstanding voltage (AC.V. rms) 1 minute | 1000 |
| Insulation resistance (MΩ MIN.) at DC 500V | 1000 |
| Contact resistance (mΩ MAX.) at DC 1A | 3 |

| | | |
|--|---------|---------|
| No. of contacts | 5 | 10 |
| Contacts Configuration | | |
| Rated voltage | 250V AC | 250V AC |
| Rated current | 15A | 10A |
| Operating voltage limit (AC.V.rms) | 400 | 250 |
| Withstanding voltage (AC.V. rms) 1 minute | 1800 | 1000 |
| Insulation resistance (MΩ MIN.) at DC 500V | 2000 | 2000 |
| Contact resistance (mΩ MAX.) at DC 1A | 3 | 3 |
| Solder internal diameter | 2.8 | 1.6 |

Socket Female Contact

Plug Male Contact

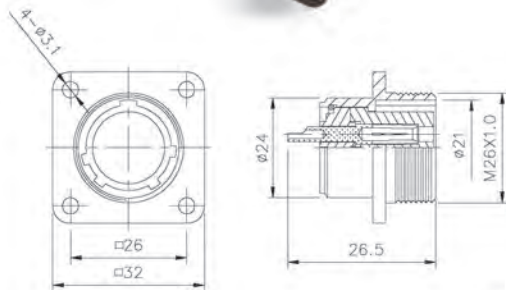

WPM-24 ◆ -PM-R

RF

PM

PLS-24 ◆ -RF-R



5 WPM SERIES

OEM / ODM

5
WPM SERIES



Plug Female Contact

WPM-1814-PF



Socket Male Contact

WPM-1814-RM



Plug Male Contact

WPM-1814-PM



Socket Female Contact

WPM-1814-RF

IPO / OEM / ODM



Plug Male Contact

WPM-3831-PM



Socket Female Contact

WPM-3831-RF

30

Waterproof Connector



Socket Female Contact

Plug Male Contact

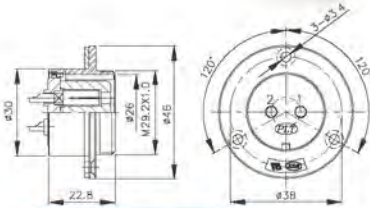

PLT-30-RF-R

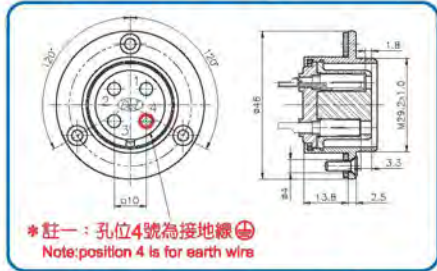

PLT-304E-RF-R



PLT-307E-RF-R

Adapter Female Contact

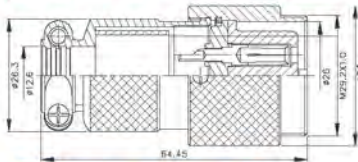

PLT-30-ADF-R

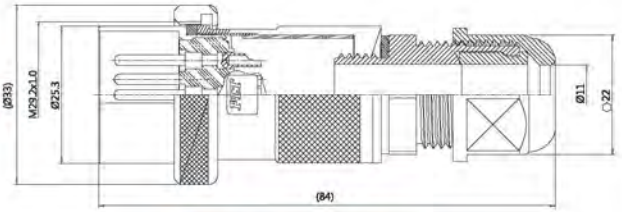

WPS-30-PM-R

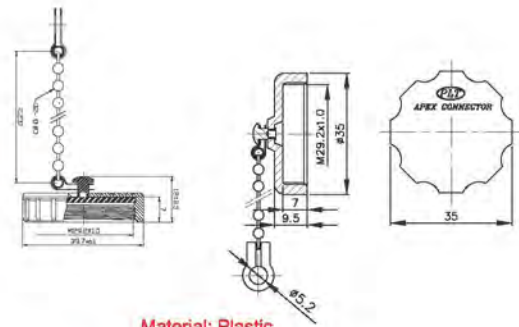

Material: Plastic
材質: 塑膠

PLT-30A-RCa-R



PAT A-591PX



PLT-30C-RCa-R

| No. of contacts | 2 | 3 | 4 | 5 | 7 | 8 | | |
|--|--------------|--------------|--------------|--------------|--------------|--------------|--|--|
| Contacts Configuration | | | | | | | | |
| Rated current / voltage | TÜV 15A 250V | TÜV 15A 250V | TÜV 15A 250V | TÜV 15A 250V | TÜV 15A 250V | TÜV 10A 250V | | |
| Operating voltage limit (AC.V.rms) | 400 | 400 | 400 | 400 | 400 | 300 | | |
| Withstanding voltage (AC.V. rms) 1 minute | 2000 | 2000 | 2000 | 1800 | 1800 | 1800 | | |
| Insulation resistance (MΩ MIN.) at DC 500V | 2000 | 2000 | 2000 | 2000 | 2000 | 2000 | | |
| Contact resistance (mΩ MAX.) at DC 1A | 3 | 3 | 3 | 3 | 3 | 3 | | |
| Solder internal diameter | 2.8 | 2.8 | 2.8 | 2.8 | 2 | 2.5 | | |

6
WPS SERIES



PLP Series 重载连接器

● ORDERING INFORMATION

PLP-116A-16B

- 16B : 16 POLE HOOD
- 16C : 16 POLE HOUSING
- 24B : 24 POLE HOOD
- 24C : 24 POLE HOUSING

- 16M : 16 POLE MALE INSERT
- 16F : 16 POLE FEMALE INSERT
- 24M : 24 POLE MALE INSERT
- 24F : 24 POLE FEMALE INSERT

- NUMBER OF CONTACTS 接点数量
- NAME OF SERIES 系列名稱



| | |
|--|-------------|
| Rated current | 16A max |
| Rated voltage | 380~450V |
| Withstanding voltage (AC.V. rms) 1 minute | 3000V |
| Contact resistance (mΩ MAX.) at DC 1A | 1 mΩ |
| Insulation resistance (MΩ MIN.) at DC 500V | 5000 mΩ |
| Water protection | IP65 |
| Temperature range | -40°C~125°C |

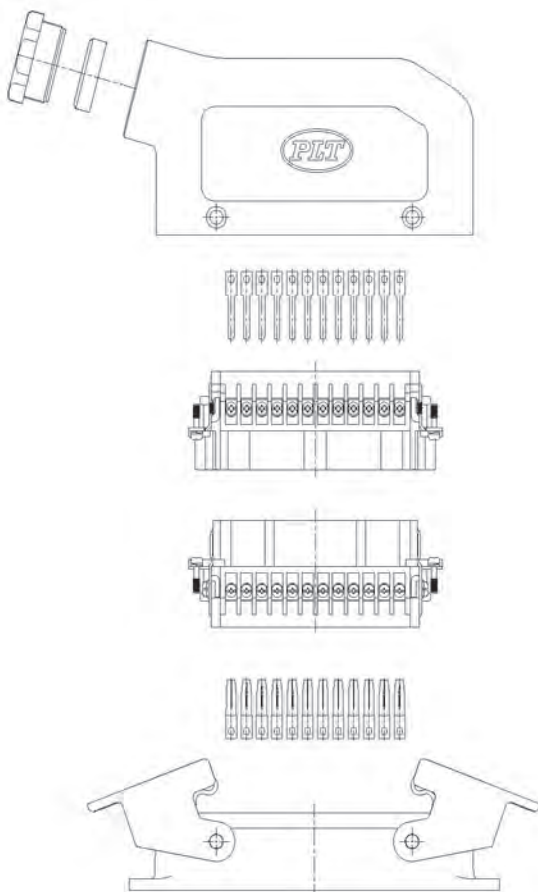

**MALE INSERT
PLP-116A-16M**

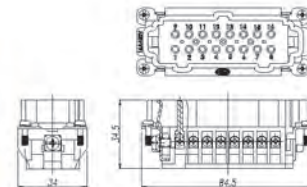

**FEMALE INSERT
PLP-116A-16F**

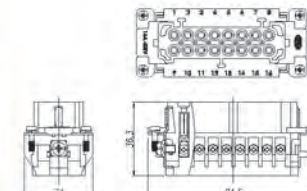

**HOODS
PLP-116A-16B**

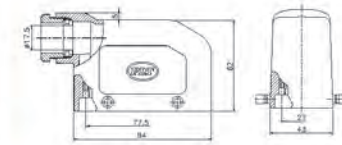

**HOUSING
PLP-116A-16C**

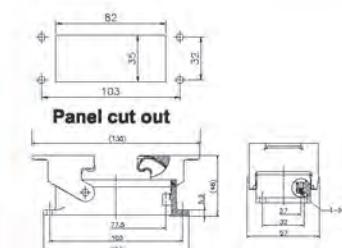

- ▲ WARNING** : Electric Shock Hazard, Do Not Hot Plugging.
- ▲ 警告** : 为避免触电, 通电状态下禁止插拔电源线连接器。
- ▲ 警告** : 感电の恐れがありますので、通电中に電源コードの挿抜を行わないでください。

PLP Series

COMPLEX SERIES 7



- PLP-124B-24B-PM
- PLP-124B-24B-PF
- PLP-124C-24B-PM
- PLP-124C-24B-PF



PLP-116A-PM



PLP-124A-PM



PLP-116A-RF



PLP-124A-RF



- PLP-124B-24B+
- PLP-124B-24C



- PLP-124B-24B-PF+
- PLP-124HI-24C-RM



- PLP-124B-24B-PF+
- PLP-124A-RM



- PLP-124A-24F+
- PLP-124A-24M

PLP-141P20 Series

PLP Series

PLP-141P20A

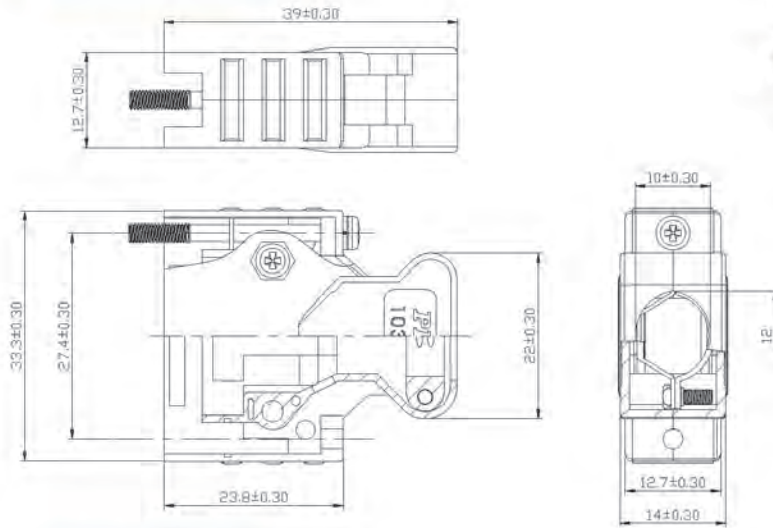

PLP-141P20B

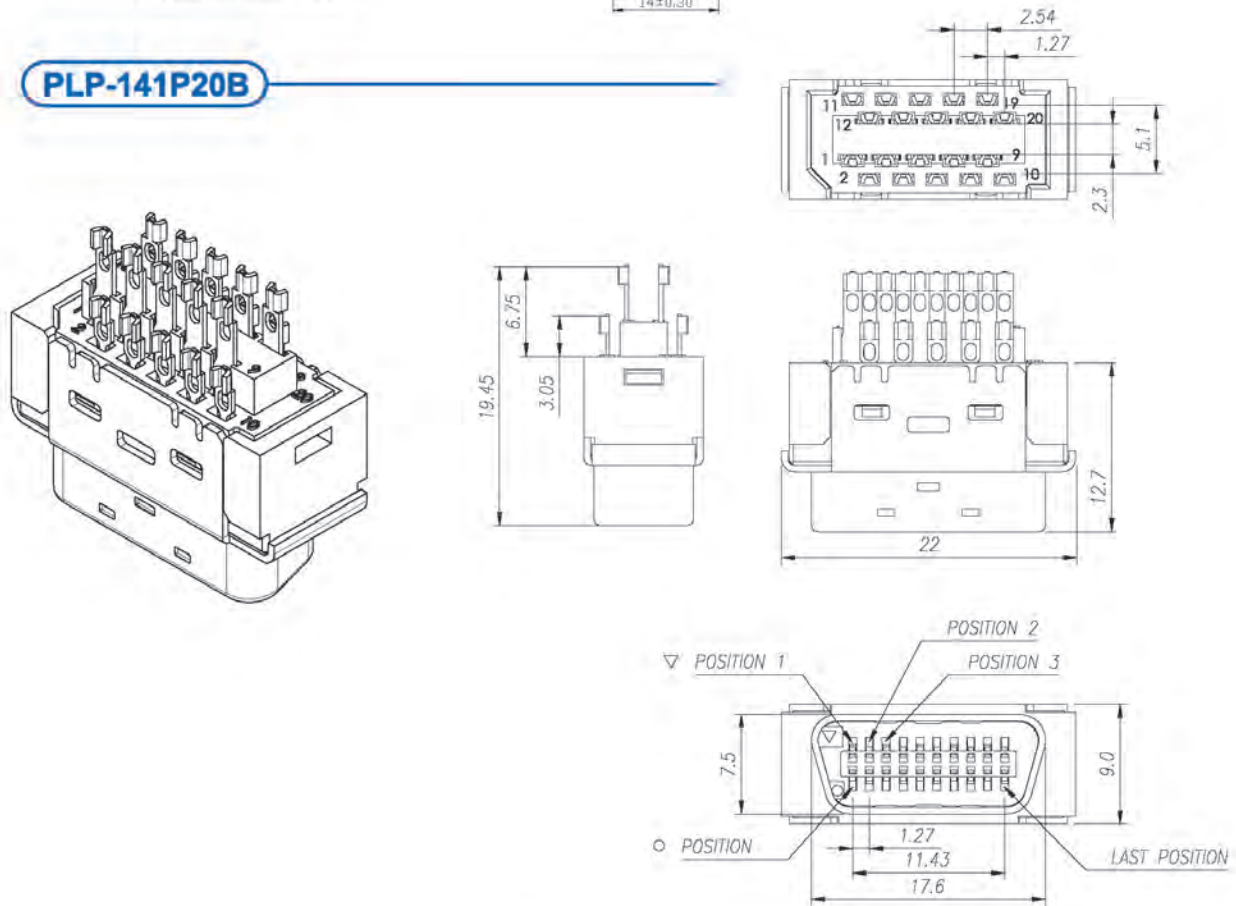

| | | | | |
|--|----------------------|--|--|--|
| No. of contacts | 20 | | | |
| Contacts Configuration | | | | |
| Rated current | 1A | | | |
| Withstanding voltage (AC.V. rms) 1 minute | 500 | | | |
| Insulation resistance (MΩ MIN.) at DC 500V | >1x10 ⁸ Ω | | | |

7
COMPLEX SERIES - PLP SERIES

PLP-154P6-R

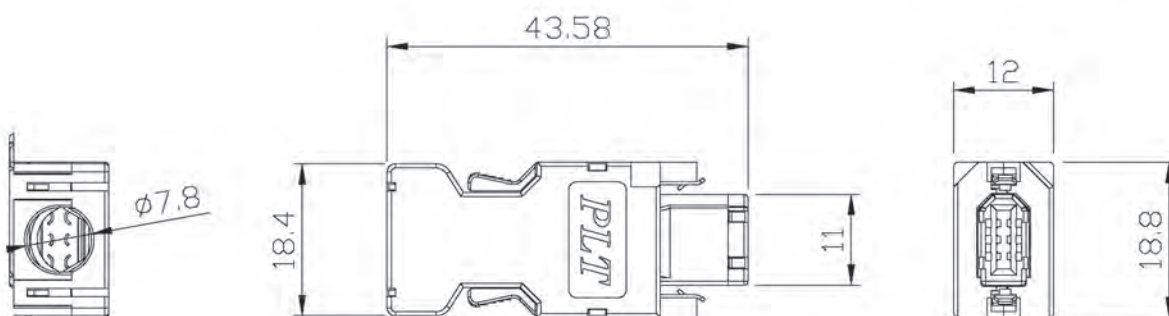
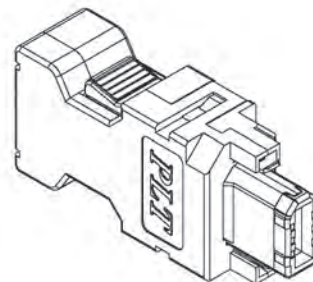
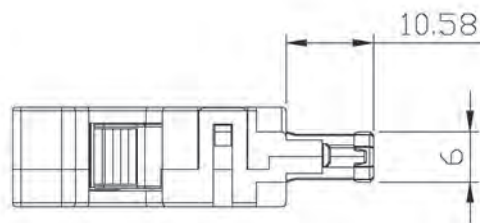

| | | | | |
|--|---|--|--|--|
| ◆ No. of contacts | 6 | | | |
| Contacts Configuration |  | | | |
| Rated current | 1A | | | |
| Withstanding voltage (AC.V. rms) 1 minute | 350 | | | |
| Insulation resistance (MΩ MIN.) at DC 500V | 1000 | | | |
| Contact resistance (mΩ MAX.) at DC 1A | 20 | | | |

Plug Male Contact

Socket Female Contact



M-6029

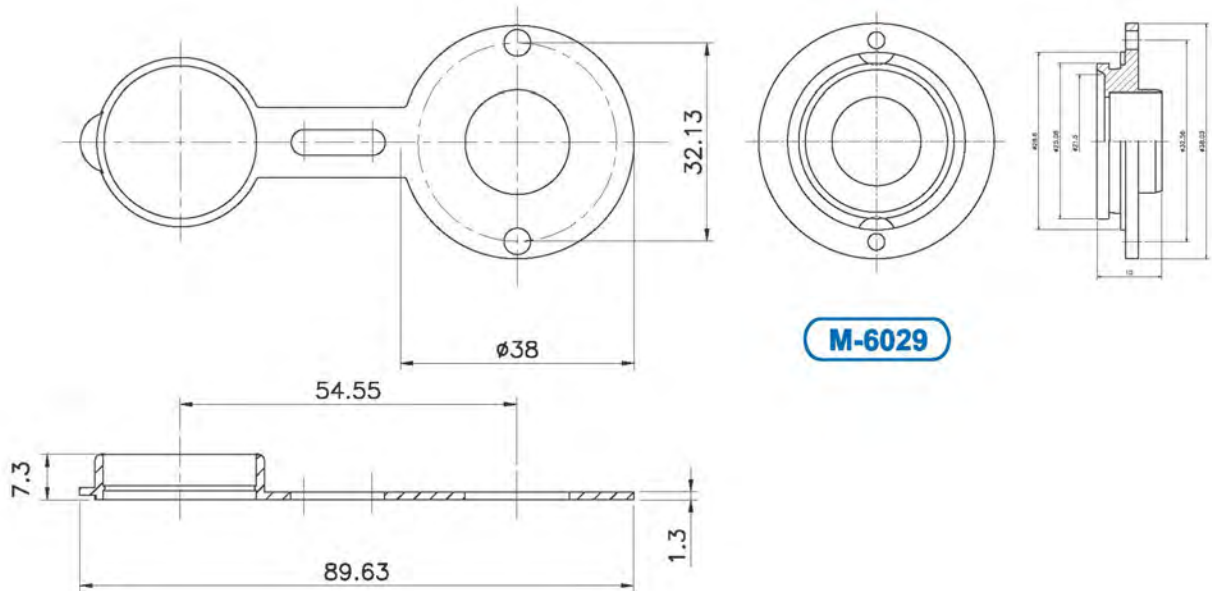
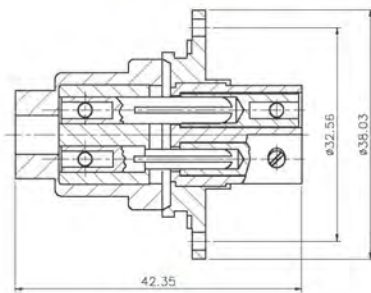

Patent of invention, all rights reserved 專利產品，仿冒必究

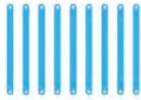

www.plt.com.tw

產品多元 / 網站查詢
Diverse products on website



BUSINESS SCOPE

The 1st Business Unit

Connector

Military / Waterproof / RF Coaxial / Industrial Series

The 2nd Business Unit

Various Types of Molds

Customized Mold and Machinery Components Design & Manufacturing

The 3rd Business Unit

Wire Assembly

The 4th Business Unit

Wireless Communication

Antenna / Transceiver / Peripheral Accessories

The 5th Business Unit

Precision Machine Manufacturing

CNC Turning and Milling Compound Lathe / Precision Arbor Press and Mechanical Press Manufacturing

The 6th Business Unit

Medical Facilities for Senior Health Care

Wireless Remote Control Patient Care System / Medical Care On-Call System

The 7th Business Unit

Channels of Distribution for Products Solution

- A S 9100D 航太國防工業品質管理系統認證通過
Quality Management Systems-Requirements For Aviation, Space, and Defense Organizations
- IATF 16949 全球汽車產業品質管理系統認證通過
Certified In Global Automobile Industry
- I S O 9001 國際品質管理系統認證通過
Environmental Management Systems
- I S O 14001 國際環境管理系統認證通過
Quality Management Systems

■ 注意事項：

1. 本目錄記載數據僅供參考，詳細內容請參考式樣書或圖面。
 2. 本目錄記載內容為了改進產品如有變更，恕不另行通知敬請見諒。
 3. UL安規認證通過項目，以UL官網 <https://app.myportal.ul.com> 或本公司提供結構圖面為憑。
 4. 防水測試等級，參照結構圖面記載為依據。
- The product information in this catalog is for reference only. Please request the engineering drawing for the most current and accurate design information.
 - In order to make improvements in the products, we reserve the right to make changes, updates and corrections to the information provided in this catalog at any time. Subject to change without notice. Thank you for your understanding.
 - The products from APEX are tested and passed by UL certification. Please check the official website of UL <https://app.myportal.ul.com> or refer to structural drawing from APEX.
 - Level of water-proof is described on structural drawing and please refer to it accordingly.

Agent / 代理商



錫鋼精密科技股份有限公司
MANUFACTURER OEM / ODM
APEX PRECISION TECHNOLOGY CORP.

總公司 / 總廠 : 24264 新北市新莊區民安西路405號 E-mail: apexmail@plt.com.tw
Headquarters No. 405, Min-an W. Rd., Sinhuang District, New Taipei City 24264, Taiwan
TEL : +886-2-2206-8899 FAX : +886-2-2208-0559

台中 / 大雅廠 : 42844 台中市大雅區民生路3段191巷4號、6號、8號 (面積8,888 m²)
Taichung Plant No. 8, Lane 191, Section 3, Minsheng Rd., Daya District, Taichung City 42844, Taiwan
TEL : +886-4-2560-7272 FAX : +886-4-2565-2228

日本分公司 : 株式会社 PLT JAPAN Technology R&D / Import & Export
Japan 〒151-0053 東京都渋谷区代々木3丁目28番-1
Branch Office 28-1, Yoyogi 3-Chome, Shibuya-ku, Tokyo, Japan
TEL : +81-3-6276-8845 FAX : +81-3-6276-6645 Mobile : +81-80-4166-2688

客訴專線 Customer complaint direct line : +886-932-921-146

100% 台灣製造
MADE IN TAIWAN



IPO 專業採購服務 策略聯盟合作夥伴
PLT 錫鋼爾也富 倉儲配銷購物網
APEX CONNECTOR CO., LTD.