

✈️ Aviation 🚗 Automobile ⚙️ Energy 🚢 Boats 🚊 Rails 🏥 Medical



APEX CONNECTORS

MILITARY SPECIFICATION

Black Trivalent Zinc Chromate Plating
Electrodeposition Coating
Olive Drab

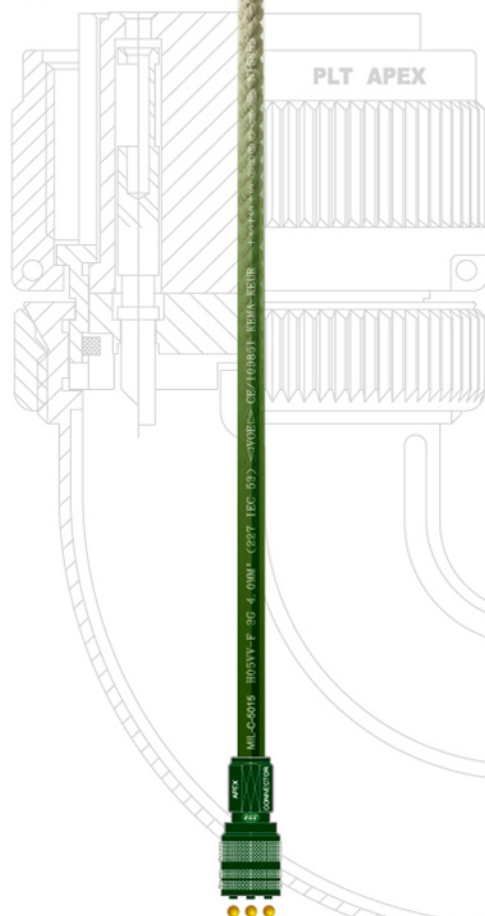

Apex connector
專業製造廠

錫鋼精密科技
APEX PRECISION TECHNOLOGY

Since 1978

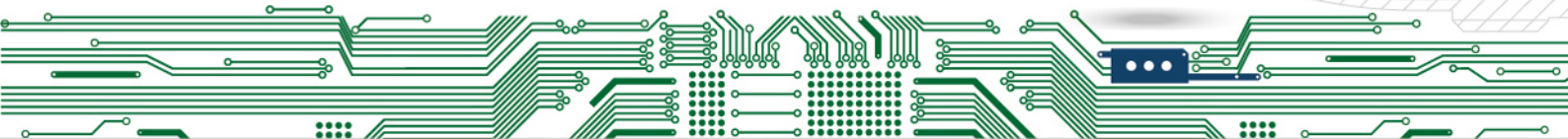

APEX Enterprise and Nature Coexistence

Coexistence of human and nature is the highest enterprise principle to APEX.
All APEX's staff and operation must be based on the premise of preserving natural environment and protecting the earth.

- Manufacturing the low-pollution products
- Manufacturing without polluting the environment
- Recycle and reuse
- Contribution to protecting the earth
- Development of environmental protection

- 1.The product information in this catalog is for reference only.
Please request the engineering drawing for the most current and accurate design information.
- 2.In order to make improvements in the products,we reserve the right to make changes, updates and corrections to the information provided in this catalog at any time.
Subject to change without notice. Thank you for your understanding.



APEX 企業與自然共存

APEX 應該視(人類和地球自然環境共存)為企業最高指導的原則，
所有的APEX職員和企業的全部運作，都要以維護自然環境、保護地球為前提。

- 製造低污染的產品
- 製造處理不汙染環境
- 所有的廢棄物回收再利用
- 為保護地球環境，貢獻一份心力
- 持續環境保護發展的工作

- 1.本目錄記載數據僅供參考，詳細內容請參考式樣書或圖面。
- 2.本目錄記載內容為了改進產品如有變更，恕不另行通知敬請見諒。

APEX企業は自然と共存します

APEXはずっと<人類と地球の共存する環境>を企業最高指導の原則とし、
全てのAPEX社員及び企業の活動は全て地球環境の保護、維持を前提としております。

- 汚染の少ない製品作り
- 製造プロセスでは環境汚染を下げる
- すべての廃棄物は回収または再利用する
- 地球環境保護のため、気力を持って貢献する
- 環盡保護発展の仕事を持続する

- 1.本カタログ記載の数値につきましては、参考数値です。詳しい内容につきましては、仕様書、図面を参考して下さい。
- 2.本カタログ記載内容は、製品向上のため予告なく変更する事がありますのでご了承下さい。

MIL-C-5015 Series

| | | |
|---|---|----|
|  | Assembly of Connector | 01 |
| AMS / WPS Series | Insert Arrangements | 02 |
| AMS / WPS Series | Insert Arrangements | 03 |
| AMS / WPS Series | Ordering Information | 04 |
| AMS / WPS Series | Ordering Information | 05 |
|  | Connector Dimension Receptacle AMS3102A | 06 |
|  | Connector Dimension Receptacle Ground Type AMS3102A 18-10PCE-RA-R AMS3102A 22-22PCE-RA-R AMS3102A 32-17PCE-RA-R | 06 |
|  | Connector Dimension Receptacle WPS3102A WPS 3100A | 07 |
|  | Connector Dimension Cable Connecting Receptacle WPS3101A AMS3101B | 08 |
|  | Connector Dimension Straight Plug AMS3106A AMS3106B | 09 |
|  | Connector Dimension Straight Plug WPS3106A European Standard DIN VDE 0627 WPS3106A 18-10SE WPS3106A 22-22SE | 10 |
|  | Connector Dimension Angled Plug AMS3108A AMS3108B | 11 |
|  | Connector Dimension Angled Plug WPS3108A European Standard DIN VDE 0627 WPS3108A 18-10SE WPS3108A 22-22SE | 12 |

MIL-C-5015 Series

| | | |
|--|--|----|
|  | Connector Dimension Cable Clamp AMS3057-*A Bushing AMS3420 | 13 |
|  | WPS Series Cable Clamp WPS3057-*A Bushing | 14 |
|  | AMS Series Cap and Chain Assembly AMS25042-**D AMS25043-**D | 15 |
|  | AMS Series Protective Caps | 16 |
|  | WPS Series WPS3101A 18-10PA-R WPS3101A 18-1PA-R WPS3106A 18-10SA-R WPS3106A 18-15A-R | 17 |
|  | AMS Series AMS3106A ACGS17-18-10S-RA-R AMS3108A ACGB17-18-10S-RA-R | 18 |
|  | WPS Series WPS3106F 14S 2S-R WPS3106A 18-10 SEA-R | 19 |

MIL-DTL-26482 Series

| | | |
|--|--|----|
|  | AMS Series AMS3122E 16-26A AMS3122A 16-26P-R AMS3126A 16-26S AMS3126A 16-26 SA-R | 20 |
|--|--|----|

MIL-DTL-26482 Series

| | | |
|--|---|----|
| | <p>AMS Series AMS3112E 12-14SE AMS3116A 12-14PA AMS3116A 12-14PB AMS3116A 12-14PC</p> | 21 |
| | <p>WPS Series WPS3112E 12-3S WPS3112E 12-8S WPS3112E 12-14S WPS3116A 12-3P WPS3116A 12-8P WPS3116A 12-14P</p> | 22 |
| | <p>WPS Series WPS3118A 12-3P WPS3118A 12-8P WPS3118A 12-14P WPS3111A 12-3S WPS3111A 12-8S WPS3111A 12-14S</p> | 23 |
| | <p>WPS Series WPS3112E 8-3PA-R WPS3116E 8-3S WPS3112E 10-6P WPS3116E 10-6S WPS3112E 12-10S WPS3116E 12-10PA-R</p> | 24 |

OTHERS

| | | |
|--|---|----|
| | <p>WPM Series WPM-3285-RM WPM-3285-RFY</p> | 25 |
| | <p>AMS Series AMS3102R AMS3106M AMS3108M</p> | 26 |
| | <p>AMS Series AMS17344R 32C-17S AMS17346R 32C-17P AMS17349C32B</p> | 27 |
| | <p>WPS Series WPS3102F 22-2P-R WPS3106F 22-2S-R WPS3102B 28-18S WPS3106B 28-18P WPS3108F 28-18P-KF009 AMS25042B-28D-R</p> | 28 |

OTHERS

| | | |
|--|---|----|
| | <p>WPM Series WPM-152-RM-R WPM-152-RMB-R WPM-152-PF-R WPM-152-LPF-R WPM-152-PFG-R WPM-152-LPFG-R WPM-152-PFB-R WPM-152-LPFB-R</p> | 29 |
| | <p>WPM Series WPM-1510-RM-R WPM-1510-RMB-R WPM-1510-PF-R WPM-1510-LPF-R WPM-1510-PFG-R WPM-1510-LPFG-R WPM-1510-PFB-R WPM-1510-LPFB-R</p> | 29 |
| | <p>WPM Series WPM-1510-AdMA-R WPM-1510-PFA</p> | 30 |
| | <p>WA Series WA-1013A-R WA-1014A-R WA-1015A-R WA-753A</p> | 31 |
| | <p>WPS Series WPS-2407-LF WPS-2407-SM WPS-2407-LM WPS-2407-SF</p> | 32 |
| | <p>PLT Series PLT-6906-R PLT-6906-P</p> <p>WPM Series WPM-107-PM-R WPM-107-ADF-R</p> | 33 |
| | <p>AMS Series AMS3204-RM AMS3204-PF AMS3204-RF AMS3204-PM</p> | 34 |

MIL-DTL-55181 Series

AMS-A/B Class connector is an assembly of socket and plug, and able to connect the panel with cable. The cable with cable fixed merely by turning the coupling nut of the plug. The electric current can be conducted according to the insertion internally. Connector is an assembly of pin and socket. Thus, either socket or plug is able to be inserted.

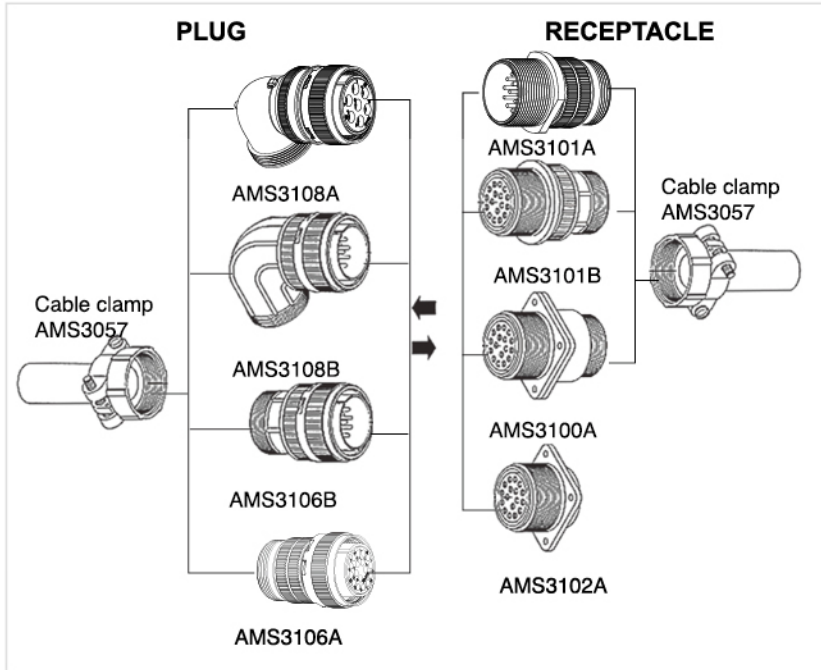

Receptacle : AMS3102A

To be installed at the body of the machine or the panel, enable it to combine with the plug for using.

Interruptible Plug : AMS3101B / AMS3101A

To be attached at the cable, connect the cable with the cable so as to combine with the plug.

Straight Plug : AMS3106B / AMS3106A

To be attached at the cable, combine with the socket and the interruptible plug. The outlet of the cable moves toward the rear side of the straight plug.

Angled Plug: AMS3108B / AMS3108A

The outlet of the cable constitutes vertical direction in contrast with the combining axis

Cable Plug: AMS3057

A connecting wire attaches on the plug and plug which is an accessory used for tightening the cable.



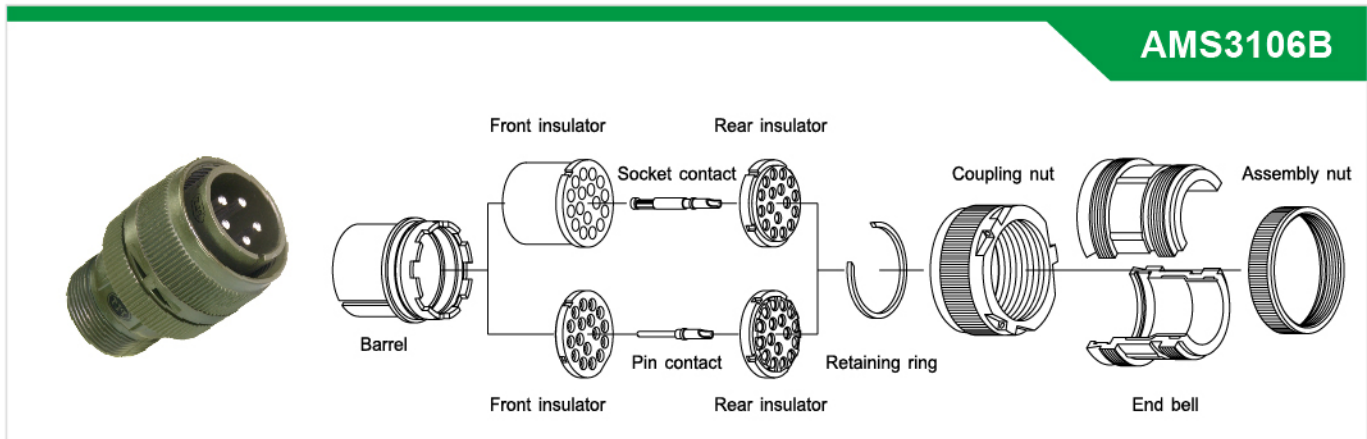
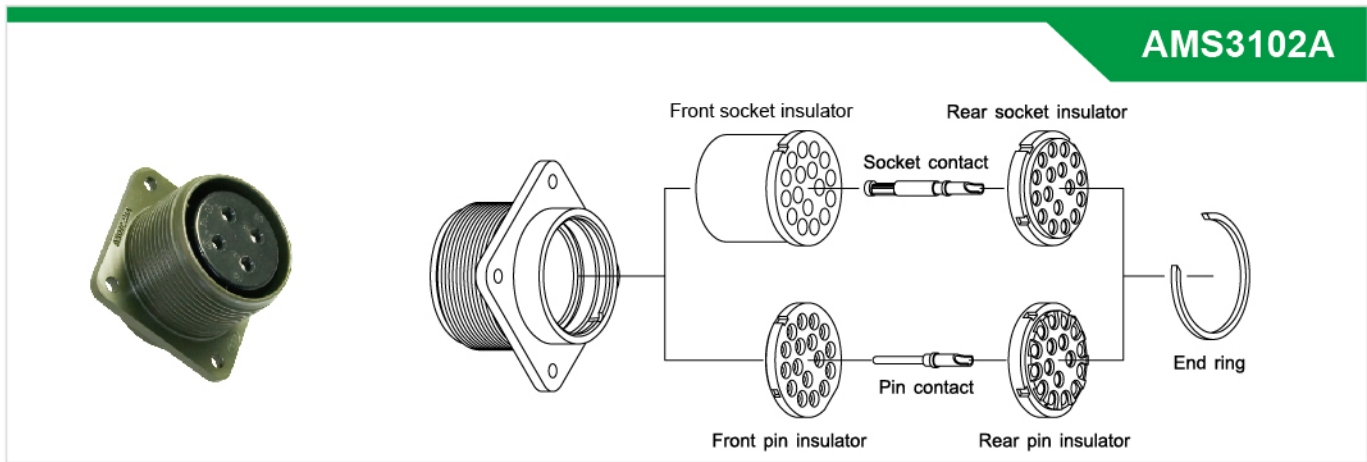







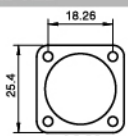



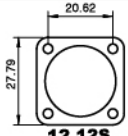

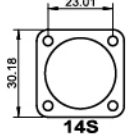







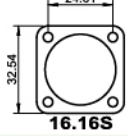



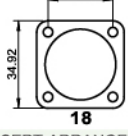





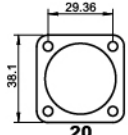



MIL-C-5015



INSERT ARRANGEMENTS

(front face of pin inserts illustrated)



MIL-C-5015





| NO. OF CONTACTS | 2 CONTACT | 3 CONTACT | | | | | |
|---|---|---|---|---|---|---|---|
| SHELL SIZE | | | | | | | |
|  |  |  | | | | | |
| 10SL |  |  | | | | | |
| ■ INSERT ARRANGEMENT | 10SL-4 | 10SL-3 | | | | | |
| ■ NUMBER OF CONTACTS | #16 x 2 Pin | #16 x 3 Pin | | | | | |
| ■ SERVICE RATING (P.S.) | INST | INST | | | | | |
| SHELL SIZE | | | | | | | |
|  |  | | | | | | |
| 12.12S |  | | | | | | |
| ■ INSERT ARRANGEMENT | 12S-3 | | | | | | |
| ■ NUMBER OF CONTACTS | #16 x 2 Pin | | | | | | |
| ■ SERVICE RATING (P.S.) | A | | | | | | |
| SHELL SIZE | | | | | | | |
|  |  |  |  |  | | | |
| 14S |  |  |  |  | | | |
| ■ INSERT ARRANGEMENT | 14S-7 | 14S-2 | 14S-5 | 14S-6 | | | |
| ■ NUMBER OF CONTACTS | #16 x 3 Pin | #16 x 4 Pin | #16 x 5 Pin | #16 x 6 Pin | | | |
| ■ SERVICE RATING (P.S.) | A | INST | INST | INST | | | |
| SHELL SIZE | | | | | | | |
|  |  |  | | | | | |
| 16.16S |  |  | | | | | |
| ■ INSERT ARRANGEMENT | 16-10 | 16S-1 | | | | | |
| ■ NUMBER OF CONTACTS | #12 x 3 Pin | #16 x 7 Pin | | | | | |
| ■ SERVICE RATING (P.S.) | A | A | | | | | |
| SHELL SIZE | | | | | | | |
|  |  |  |  | | | | |
| 18 |  |  |  | | | | |
| ■ INSERT ARRANGEMENT | 18-10 | 18-11 | 18-1 | | | | |
| ■ NUMBER OF CONTACTS | #12 x 4 Pin | #12 x 5 Pin | #16 x 10 Pin | | | | |
| ■ SERVICE RATING (P.S.) | A | A | A(B.C.F.G) INST(Other) | | | | |
| SHELL SIZE | | | | | | | |
|  |  |  |  |  |  |  |  |
| 20 |  |  |  |  |  |  |  |
| ■ INSERT ARRANGEMENT | 20-4 | 20-17 | 20-15 | 20-16 | 20-18 | 20-27 | 20-29 |
| ■ NUMBER OF CONTACTS | #12 x 4 Pin | #12x5Pin(A-E)#16x1Pin(F) | #12 x 7 Pin | #16 x 7 Pin(A-G) #12 x 2 Pin(H) | #12 x 3 Pin(B,F,E) #16 x 6 Pin(A,H,G,C,D,E) | #16 x 14 Pin | #16 x 17 Pin |
| ■ SERVICE RATING (P.S.) | D | D | A | A | A | A | A |

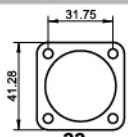
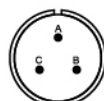
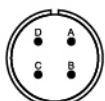
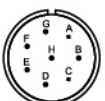



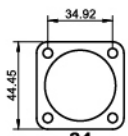
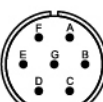

備註: ■ 連接方位組合 ■ 端子尺寸和數量 ■ 額定區分 P.S. : Please refer to page 5

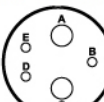

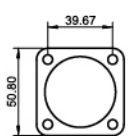
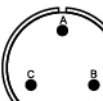

INSERT ARRANGEMENTS

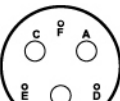

(front face of pin inserts illustrated)

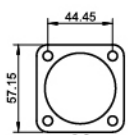
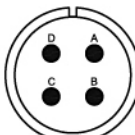
| NO. OF CONTACTS | 3 CONTACT | 4 CONTACT | 8 CONTACT | 19 CONTACT | 14 CONTACT |
|-------------------------|---|---|---|---|---|
| SHELL SIZE |  | | | | |
| |  |  |  |  |  |
| ■ INSERT ARRANGEMENT | TUV | TUV | TUV | TUV | TUV |
| ■ NUMBER OF CONTACTS | 22-2 #8 x 3 Pin | 22-22 #8 x 4 Pin | 22-23 #12 x 8 Pin | 22-14 #16 x 19 Pin | 22-19 #16 x 14 Pin |
| ■ SERVICE RATING (P.S.) | D | D | D(H).A(Other) | A | A |

| NO. OF CONTACTS | 7 CONTACT | 9 CONTACT | 11 CONTACT | 16 CONTACT | 24 CONTACT | 5 CONTACT |
|-------------------------|---|---|---|--|---|---|
| SHELL SIZE |  | | | | | |
| |  |  |  |  |  |  |
| ■ INSERT ARRANGEMENT | TUV | TUV | TUV | TUV | TUV | 開發中 DEVELOPING |
| ■ NUMBER OF CONTACTS | 24-10 #8 x 7 Pin | 24-11 #8 x 3 Pin(D,E,F) #12 x 6 Pin(Other) | 24-20 #16 x 9 Pin(A-D,G-L) #12 x 2 Pin(E,F) | 24-7 #16 x 14 Pin(A-M,O) #12 x 2 Pin(P,N) | 24-28 #16 x 24 Pin | 24-12 #4 x 2 Pin(A-C) #12 x 3 Pin(B,D,E) |
| ■ SERVICE RATING (P.S.) | A | A | D | A | INST | A |

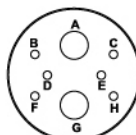
| NO. OF CONTACTS | 3 CONTACT | 14 CONTACT | 22 CONTACT | 26 CONTACT | 20 CONTACT | 37 CONTACT | 6 CONTACT |
|-------------------------|---|---|---|---|---|---|---|
| SHELL SIZE |  | | | | | | |
| |  |  |  |  |  |  |  |
| ■ INSERT ARRANGEMENT | TUV | TUV | TUV | TUV | 開發中 DEVELOPING | TUV | TUV |
| ■ NUMBER OF CONTACTS | 28-6 #4 x 3 Pin | 28-20 #16 x 4 Pin(K,L,M,N) #12 x 10 Pin(A-J,P) | 28-11 #16 x 18 Pin(A-I,N-X) #12 x 4 Pin(J,K,L,M) | 28-12 #16 x 26 Pin | 28-18 #8 x 3 Pin(K-M) #10 x 4 Pin(A-D) #20 x 5 Pin(E-J) #22 x 8 Pin(N-W) | 28-21 #16 x 37 Pin | 28-22 #4 x 3 Pin(A-C) #16 x 3 Pin(D-F) |
| ■ SERVICE RATING (P.S.) | D | A | A | A | A | A | D |

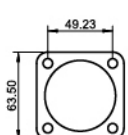
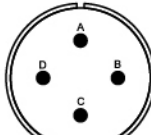
| NO. OF CONTACTS | 4 CONTACT | 35 CONTACT | 54 CONTACT | 2 CONTACT | 8 CONTACT |
|-------------------------|---|---|---|---|---|
| SHELL SIZE |  | | | | |
| |  |  |  |  |  |
| ■ INSERT ARRANGEMENT | TUV | 開發中 DEVELOPING | 開發中 DEVELOPING | 開發中 DEVELOPING | TUV |
| ■ NUMBER OF CONTACTS | 32-17 #4 x 4 Pin | 32-7 #16 x 28 Pin(A-N,W-Z,a-k) #12 x 7 Pin(O-V) | 32A10 (32-22) #16 x 54 Pin | 32-5 #0 x 2 Pin | 32-15 #0 x 2 Pin(A,G) #12 x 6 Pin(B-F,H) |
| ■ SERVICE RATING (P.S.) | D | INST(A,B,h,j)A(Other) | A | D | D |

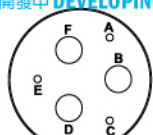
| NO. OF CONTACTS | 4 CONTACT | 48 CONTACT | 6 CONTACT |
|-------------------------|---|---|---|
| SHELL SIZE |  | | |
| |  |  |  |
| ■ INSERT ARRANGEMENT | 36-5 | 36-10 | 36-3 |
| ■ NUMBER OF CONTACTS | #0 x 4 Pin | #16 x 48 Pin | #0 x 2 Pin(B,D,F) #12 x 3 Pin(A,C,E) |
| ■ SERVICE RATING (P.S.) | A | A | D |

備註: ■ 連接方位組合 ■ 端子尺寸和數量 ■ 額定區分

P.S. : Please refer to page 5

INSERT ARRANGEMENTS

(front face of pin inserts illustrated)

| NO. OF CONTACTS | 3 CONTACT | 4 CONTACT | 8 CONTACT | 19 CONTACT | 14 CONTACT |
|-------------------------|--------------------|---------------------|----------------------|-----------------------|-----------------------|
| SHELL SIZE | | | | | |
| | | | | | |
| ■ INSERT ARRANGEMENT | TUV | TUV | TUV | TUV | TUV |
| ■ NUMBER OF CONTACTS | 22-2 #8 x 3 Pin | 22-22 #8 x 4 Pin | 22-23 #12 x 8 Pin | 22-14 #16 x 19 Pin | 22-19 #16 x 14 Pin |
| ■ SERVICE RATING (P.S.) | D | D | D(H).A(Other) | A | A |

| NO. OF CONTACTS | 7 CONTACT | 9 CONTACT | 11 CONTACT | 16 CONTACT | 24 CONTACT | 5 CONTACT |
|-------------------------|---------------------|--|---|---|-----------------------|--|
| SHELL SIZE | | | | | | |
| | | | | | | |
| ■ INSERT ARRANGEMENT | TUV | TUV | TUV | TUV | TUV | TUV |
| ■ NUMBER OF CONTACTS | 24-10 #8 x 7 Pin | 24-11 #8 x 3 Pin(D.E.F) #12 x 6 Pin(Other) | 24-20 #16 x 9 Pin(A-D.G-L) #12 x 2 Pin(E.F) | 24-7 #16 x 14 Pin(A-M.O) #12 x 2 Pin(P.N) | 24-28 #16 x 24 Pin | 24-12 #4 x 2 Pin(A-C) #12 x 3 Pin(B.D.E) |
| ■ SERVICE RATING (P.S.) | A | A | D | A | INST | A |

| NO. OF CONTACTS | 3 CONTACT | 14 CONTACT | 22 CONTACT | 26 CONTACT | 20 CONTACT | 37 CONTACT | 6 CONTACT |
|-------------------------|--------------------|--|--|-----------------------|--|-----------------------|--|
| SHELL SIZE | | | | | | | |
| | | | | | | | |
| ■ INSERT ARRANGEMENT | TUV | TUV | TUV | TUV | TUV | TUV | TUV |
| ■ NUMBER OF CONTACTS | 28-6 #4 x 3 Pin | 28-20 #16 x 4 Pin(K.L.M.N) #12 x 10 Pin(A-J.P) | 28-11 #16 x 18 Pin(A-I.N-X) #12 x 4 Pin(J.K.L.M) | 28-12 #16 x 26 Pin | 28-18 #8 x 3 Pin(K-M)·#10 x 4 Pin(A-D) #20 x 5 Pin(E-J)·#22 x 8 Pin(N-W) | 28-21 #16 x 37 Pin | 28-22 #4 x 3 Pin(A-C) #16 x 3 Pin(D-F) |
| ■ SERVICE RATING (P.S.) | D | A | A | A | A | A | D |

| NO. OF CONTACTS | 4 CONTACT | 35 CONTACT | 54 CONTACT | 2 CONTACT | 8 CONTACT |
|-------------------------|---------------------|---|-------------------------------|--------------------|--|
| SHELL SIZE | | | | | |
| | | | | | |
| ■ INSERT ARRANGEMENT | TUV | TUV | TUV | TUV | TUV |
| ■ NUMBER OF CONTACTS | 32-17 #4 x 4 Pin | 32-7 #16 x 28 Pin(A-N.W-Z.a-K) #12 x 7 Pin(O-V) | 32A10 (32-22) #16 x 54 Pin | 32-5 #0 x 2 Pin | 32-15 #0 x 2 Pin(A.G) #12 x 6 Pin(B-F.H) |
| ■ SERVICE RATING (P.S.) | D | INST(A.B.h.j)A(Other) | A | D | D |

| NO. OF CONTACTS | 4 CONTACT | 48 CONTACT | 6 CONTACT | | |
|-------------------------|--------------------|-----------------------|---|--|--|
| SHELL SIZE | | | | | |
| | | | | | |
| ■ INSERT ARRANGEMENT | TUV | TUV | TUV | | |
| ■ NUMBER OF CONTACTS | 36-5 #0 x 4 Pin | 36-10 #16 x 48 Pin | 36-3 #0 x 2 Pin(B.D.F) #12 x 3 Pin(A.C.E) | | |
| ■ SERVICE RATING (P.S.) | A | A | D | | |

備註: ■ 連接方位組合 ■ 端子尺寸和數量 ■ 額定區分

P.S. : Please refer to page 5

MIL-C-5015

ORDERING INFORMATION 訂購資訊

| | | | | | | | | |
|---|--|--|--------------------------------------|-----------------------------|--|----------------------------|---|----------|
| AMS / WPS | 3106B / 3106A | 24-10 | S | C | YE | DA | G | R |
| SERIES 產品系列 | | INSERT ARRANGEMENT 連接方位組合 See page 2 to 3 | CONTACT STYLE P: Pin 導針 S: Socket 導梢 | INSULATOR 絕緣體 C: Silicon 矽膠 | Finish 表面處理 Olive Drab OD色 EDP (Black) 黑色電著 EDP (Green) 綠色電著 CR3+(Black) 黑色三價鉻 | Bakelite 電木 N / A B C-R -R | Rubber 橡膠 DA BA-R CA-R RA-R | R: RoHS |
| SHELL STYLE 外殼型式 3101B: Cable mounting receptacle, split shell 電纜中繼式, 分離式外殼 3106B: Straight plug, split shell 180°直接頭, 分離式外殼 3108B: Angled plug, split shell 90°彎接頭, 分離式外殼 3100A: Wall mounting receptacle 面板固定端座 | SHELL STYLE 外殼型式 3101A: Cable Mounting receptacle, solid shell 電纜中繼式, 單件式外殼 3102A: Box Mounting receptacle, solid shell 箱體固定端座, 單件式外殼 3106A: Straight plug, solid shell 180°直接頭, 單件式外殼 3108A: Angled plug, solid shell 90°彎接頭, 單件式外殼 | | | | ALTERNATE INSERT POSITION 可變換的接觸角位 OMIT: Standard position 正常角位 W.X.Y.Z: Revolving position 旋轉角位 E: 接地線 Ground wire | | REMARKS 備註: STANDARD 標準 Silver plated contacts 鍍銀 G: Gold plated contacts 鍍金 | |

ORDERING INFORMATION 訂購資訊

In contrast with the standard insert position. After the guide key of its shell is formed into certain angle, the position change shall be indicated by the marks W,X,Y,Z. According to the layout of connector, there is difference in the changeable angles. Please refer to the below instructions.

本公司此系列產品出廠前已有標準的角位排列，如客戶欲訂購特殊的不同角位，請參考以下的說明。



Standard Position

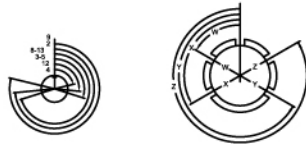

| No. of Contacts | Insert No. | Revolving Angle | | | |
|-----------------|------------|-----------------|-----|-----|-----|
| | | W | X | Y | Z |
| 2 | 12S-3 | 70 | 145 | 215 | 290 |
| | 32-15 | 35 | 110 | 250 | 280 |
| 3 | 14S-7 | 90 | 180 | 270 | - |
| | 16-10 | 90 | 180 | 270 | - |
| | 22-2 | 70 | 145 | 215 | 290 |
| 4 | 28-6 | 70 | 145 | 215 | 290 |
| | 14S-2 | - | 120 | 240 | - |
| | 18-10 | - | 120 | 240 | - |
| | 20-4 | 45 | 110 | 250 | - |
| 5 | 22-22 | - | 110 | 250 | - |
| | 32-17 | 45 | 110 | 250 | - |
| | 36-5 | - | 120 | 240 | - |
| 6 | 18-11 | - | 170 | 265 | - |
| | 20-17 | 90 | 180 | 270 | - |
| 7 | 28-22 | 70 | 145 | 215 | 290 |
| | 36-3 | 70 | 145 | 215 | 290 |
| | 16S-1 | 80 | - | - | 280 |
| 8 | 20-15 | 80 | - | - | 280 |
| | 24-10 | 80 | - | - | 280 |
| | 22-23 | 13 | - | 250 | - |
| 9 | 20-16 | 80 | 110 | 250 | 280 |
| | 20-18 | 35 | 110 | 250 | 325 |
| 10 | 24-11 | 35 | 110 | 250 | 325 |
| | 18-1 | 70 | 145 | 215 | 290 |
| 11 | 24-20 | 80 | 110 | 250 | 280 |
| | 20-27 | 35 | 110 | 250 | 325 |
| 14 | 28-20 | 80 | 110 | 250 | 280 |
| | 24-7 | 80 | 110 | 250 | 280 |
| 17 | 20-29 | 80 | - | - | 280 |
| 19 | 22-14 | 80 | - | - | 280 |
| 22 | 28-11 | 80 | 110 | 250 | 280 |
| 24 | 24-28 | 80 | 110 | 250 | 280 |
| 26 | 28-12 | 90 | 180 | 270 | - |
| 37 | 28-21 | 80 | 110 | 250 | 280 |
| 48 | 36-10 | 80 | 125 | 235 | 280 |
| 100 | 48-5 | 65 | 125 | 225 | 310 |

The connector's layout 32-7 and 36-10 are same in the revolving angle.

| | | | | | | |
|-----------------|-----|--------|----|---------|-----|-----|
| Mark | 2 | 3 or 5 | 4 | 8 or 13 | 9 | 12 |
| Revolving Angle | 260 | 110 | 80 | 250 | 280 | 100 |

ORDERING INFORMATION 訂購資訊

SERVICE RATING

| Service Rating | Operating Voltage(V) | |
|----------------|----------------------|--------------|
| | DC.V | AC.V(r.m.s.) |
| INST | 250 | 200 |
| A | 700 | 500 |
| D | 1250 | 900 |
| E | 1750 | 1250 |
| B | 2450 | 1750 |
| C | 4200 | 3000 |

RECEPTACLE

| | |
|--------------------------|---|
| Shell 本體 | Al-Alloy / 鋁合金 |
| Front Insulator 絕緣蓋 | Silicone (Waterproof) / 防水矽膠 Polyester (Non-Waterproof) / 非防水合成樹脂 |
| Rear Insulator 絕緣座 | Polyester / 合成樹脂 |
| Contact 導針 | Copper / Ag-plated / 銅合金 / 鍍銀 |
| Retaining Ring 扣環 | Copper Alloy / 銅合金 |
| Contact Assembly 導稍總成 | Copper Alloy / 銅合金 |

CONTACT CURRENT RATING

| Contact Size | Test Current (Amperes) |
|--------------|------------------------|
| #16 | 13 |
| #12 | 23 |
| #8 | 46 |
| #4 | 80 |
| #0 | 150 |

PLUG

| | |
|----------------------|-------------------------------|
| Shell 本體 | Al-Alloy / 鋁合金 |
| Insulator 絕緣體 | Polyester / 合成樹脂 |
| Gasket 橡膠墊 | Rubber / 橡膠 |
| Contact 導針 | Copper / Ag-plated / 銅合金 / 鍍銀 |
| Sleeve 套管 | Polyester / 合成樹脂 |
| Retaining Ring 扣環 | Copper Alloy / 銅合金 |
| Screw 螺絲 | Steel / 鋼 |
| O-Ring O形環 | Rubber / 橡膠 |
| Screw 金屬螺絲 | Steel / 鋼 |

OPERATING TEMPERATURE

-55°C~+125°C

WIRE SIZE

| Contact | | Wire Size AWG |
|---------|-------------|---------------|
| Size | Solder Hold | |
| #16 | 1.85 Ø | #16~#22 |
| #12 | 2.95 Ø | #12~#14 |
| #8 | 5.31 Ø | #8~#10 |
| #4 | 8.45 Ø | #4~#6 |
| #0 | 11.91 Ø | #0~#2 |

IP CODE



■ IEC/EN 60529 為現今國際上最常引用作為產品外殼機構保護等級的規範，故也稱為“國際保護等級，IP Code”

RECEPTACLE **AMS3102A**



SOCKET



PIN PLUG

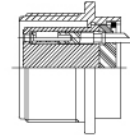
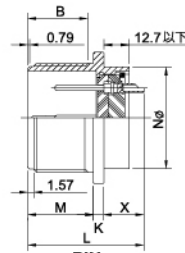
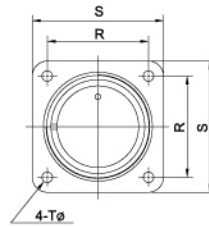

SOCKET

| Shell size | Coupling Threads | Length of the effective portion of the thread over B | Thickness of the assembly rim under K | Length L | Length of assembly rim M +0.79 N - 0 | Outer radius of the terminal N + 0 N - 0.13 | Position of the holes reserved for assembly R ± 0.13 | Length of the protruded sides S ± 0.79 | Hole diameter of the assembly holes T +0.25 - 0.13 |
|------------|------------------|--|---------------------------------------|----------|--|---|---|---|--|
| 10SL | 5/8-24UNEF-2A | 9.50 | 2.1 | 23.4 | 14.60 | 15.80 | 18.26 | 25.40 | 3.10 |
| 12S | 3/4-20UNEF-2A | 9.52 | 2.4 | 24.3 | 14.27 | 17.46 | 20.62 | 27.79 | 3.05 |
| 14S | 7/8-20UNEF-2A | 9.52 | 2.4 | 24.3 | 14.27 | 19.05 | 23.01 | 30.18 | 3.05 |
| 16S | 1-20UNEF-2A | 9.52 | 2.4 | 24.3 | 14.27 | 22.22 | 24.61 | 32.54 | 3.05 |
| 16 | 1-20UNEF-2A | 15.88 | 2.4 | 29.1 | 19.05 | 22.22 | 24.61 | 32.54 | 3.05 |
| 18 | 1-1/8-18UNEF-2A | 15.88 | 3.0 | 28.6 | 19.05 | 25.40 | 26.97 | 34.92 | 3.05 |
| 20 | 1-1/4-18UNEF-2A | 15.88 | 3.0 | 29.4 | 19.05 | 29.50 | 29.36 | 38.10 | 3.05 |
| 22 | 1-3/8-18UNEF-2A | 15.88 | 3.0 | 29.4 | 19.05 | 31.80 | 31.75 | 41.28 | 3.05 |
| 24 | 1-1/2-18UNEF-2A | 15.88 | 3.0 | 33.4 | 20.62 | 35.10 | 34.92 | 44.45 | 3.73 |
| 28 | 1-3/4-18UNS-2A | 15.88 | 3.0 | 33.4 | 20.62 | 41.58 | 39.67 | 50.80 | 3.73 |
| 32 | 2-18UNS-2A | 15.88 | 4.3 | 33.4 | 22.22 | 48.26 | 44.45 | 57.15 | 4.39 |
| 36 | 2-1/4-16UN-2A | 15.88 | 4.3 | 33.4 | 22.22 | 53.97 | 49.23 | 63.50 | 4.39 |
| 48 | 3-16UN-2A | 15.88 | 4.3 | 33.2 | 22.22 | 77.90 | 66.68 | 82.55 | 4.39 |

PS.:Shell size and insert arrangement, please refer to page 2-3

RECEPTACLE GROUND TYPE **AMS3102A**

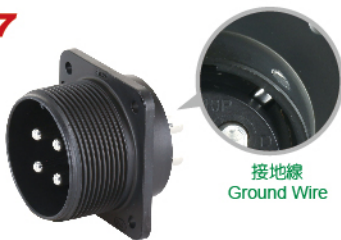

接地線
Ground Wire





AMS3102A 18-10PCE-RA-R

AMS3102A 22-22PCE-RA-R

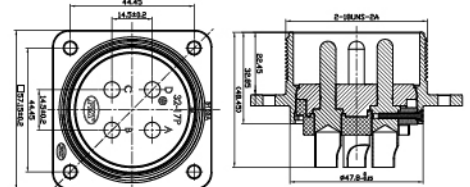
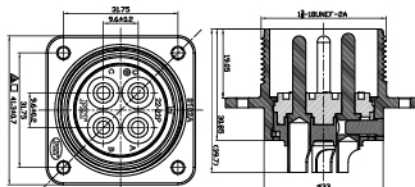
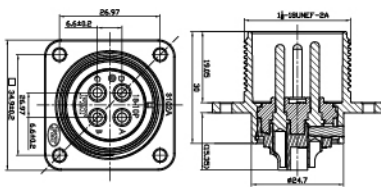
AMS3102A 32-17PCE-RA-R



| No. of contacts | AMS3102A 18-10PCE-RA-R | AMS3102A 22-22PCE-RA-R | AMS3102A 32-17PCE-RA-R |
|--|---|---|---|
| Contacts Configuration |  |  |  |
| Rated current / voltage | 15A 200V | 15A 900V | 15A 900V |
| Operating voltage limit (AC.V.rms) | 200 | 900 | 900 |
| Withstanding Voltage (AC.V.rms) 1 minute | 2000 | 2000 | 2800 |
| Test Current (Amperes) | 23 | 46 | 80 |
| Insulation Resistance (Ωmin. at DC 500V) | 5000M | 5000M | 5000M |

WPS3102A

RECEPTACLE



GASKET



PIN PLUG



SOCKET

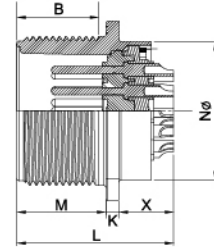
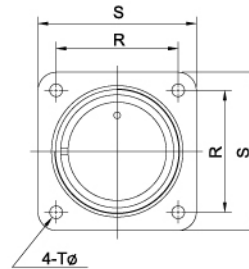

| Shell size | Coupling Threads | Length of the effective portion of the thread over B | Thickness of the assembly rim under K | Length L | Length of assembly rim M +0.79 - 0 | Outer radius of the terminal N +0 - 0.13 | Position of the holes reserved for assembly R ± 0.13 | Length of the protruded sides S ± 0.79 | Hole diameter of the assembly holes T +0.25 - 0.13 |
|------------|------------------|--|---------------------------------------|----------|--|--|---|---|--|
| 10SL | 5/8-24UNEF-2A | 9.50 | 2.1 | 23.4 | 14.60 | 15.80 | 18.26 | 25.40 | 3.10 |
| 12S | 3/4-20UNEF-2A | 9.52 | 2.4 | 24.3 | 14.27 | 17.46 | 20.62 | 27.79 | 3.05 |
| 14S | 7/8-20UNEF-2A | 9.52 | 2.4 | 24.3 | 14.27 | 19.05 | 23.01 | 30.18 | 3.05 |
| 16S | 1-20UNEF-2A | 9.52 | 2.4 | 24.3 | 14.27 | 22.22 | 24.61 | 32.54 | 3.05 |
| 16 | 1-20UNEF-2A | 15.88 | 2.4 | 29.1 | 19.05 | 22.22 | 24.61 | 32.54 | 3.05 |
| 18 | 1-1/8-18UNEF-2A | 15.88 | 3.0 | 28.6 | 19.05 | 25.40 | 26.97 | 34.92 | 3.05 |
| 20 | 1-1/4-18UNEF-2A | 15.88 | 3.0 | 29.4 | 19.05 | 29.50 | 29.36 | 38.10 | 3.05 |
| 22 | 1-3/8-18UNEF-2A | 15.88 | 3.0 | 29.4 | 19.05 | 31.80 | 31.75 | 41.28 | 3.05 |
| 24 | 1-1/2-18UNEF-2A | 15.88 | 3.0 | 33.4 | 20.62 | 35.10 | 34.92 | 44.45 | 3.73 |
| 28 | 1-3/4-18UNS-2A | 15.88 | 3.0 | 33.4 | 20.62 | 41.58 | 39.67 | 50.80 | 3.73 |
| 32 | 2-18UNS-2A | 15.88 | 4.3 | 33.4 | 22.22 | 48.26 | 44.45 | 57.15 | 4.39 |
| 36 | 2-1/4-16UN-2A | 15.88 | 4.3 | 33.4 | 22.22 | 53.97 | 49.23 | 63.50 | 4.39 |
| 48 | 3-16UN-2A | 15.88 | 4.3 | 33.2 | 22.22 | 77.90 | 66.68 | 82.55 | 4.39 |

PS : Shell size and insert arrangement please refer to page 2 3

WPS3100A

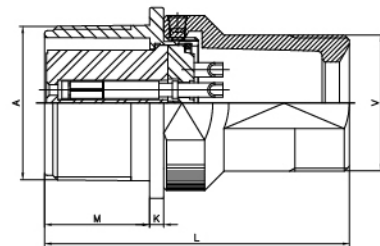
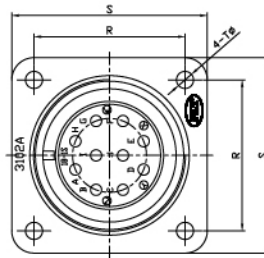

| Shell size | Coupling Threads A | Length L | Thickness of the assembly rim under K | Length of assembly rim M + 0.79 - 0 | Rear Threads V | Position of the holes reserved for assembly R ± 0.13 | Length of the protruded sides S ± 0.79 | Hole diameter of the assembly holes T +0.25 - 0.13 |
|------------|--------------------|----------|---------------------------------------|---|-----------------|---|---|--|
| 10SL | 5/8-24UNEF-2A | 45 | 2.1 | 14.6 | 5/8-24UNEF-2A | 18.26 | 25.4 | 3.1 |
| 14S | 7/8-20UNEF-2A | 44.2 | 2.1 | 14.27 | 7/8-20UNEF-2A | 23.01 | 30.18 | 3.05 |
| 16S | 1-20UNEF-2A | 41.1 | 2.1 | 14.27 | 1-20UNEF-2A | 24.61 | 32.5 | 3.1 |
| 18 | 1-1/8-18UNEF-2A | 55.8 | 2.6 | 28.6 | 1-1/8-18UNEF-2A | 26.97 | 34.92 | 3.05 |
| 20 | 1-1/4-18UNEF-2A | 56.5 | 2.7 | 29.4 | 1-1/4-18UNEF-2A | 29.36 | 38.10 | 3.05 |
| 22 | 1-3/8-18UNEF-2A | 66.4 | 2.7 | 29.4 | 1-3/8-18UNEF-2A | 31.75 | 41.28 | 3.05 |
| 24 | 1-1/2-18UNEF-2A | 58.5 | 2.7 | 33.4 | 1-1/2-18UNEF-2A | 34.9 | 44.4 | 3.75 |
| 28 | 1-3/4-18UNS-2A | 59.1 | 2.7 | 33.4 | 1-3/4-18UNS-2A | 39.7 | 50.8 | 3.75 |

PS. : Shell size and insert arrangement, please refer to page 2-3.

MIL-C-5015

CABLE CONNECTING RECEPTACLE

WPS3101A

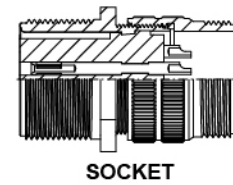
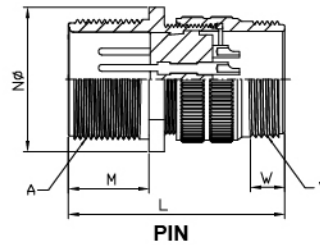
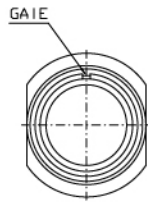

SOCKET

PIN

| Shell Size | Coupling Threads A | Length L | The length to the assembly rim M + 0.4 | Outer radius under N | Rear Threads V | Length of thread over W |
|------------|--------------------|----------|---|----------------------|----------------|-------------------------|
| 10SL | 5/8-24UNEF | 38.89 | 14.27 | 24.61 | 5/8-24UNEF | 9.5 |
| 12s | 3/4-20UNEF | 42.88 | 14.27 | 26.97 | 5/8-24UNEF | 9.5 |
| 12 | 3/4-20UNEF | 52.37 | 19.05 | 26.97 | 5/8-24UNEF | 9.5 |
| 14s | 7/8-20UNEF | 42.88 | 14.27 | 29.36 | 3/4-20UNEF | 9.5 |
| 14 | 7/8-20UNEF | 52.37 | 19.05 | 29.36 | 3/4-20UNEF | 9.5 |
| 16s | 1-20UNEF | 42.88 | 14.27 | 31.75 | 7/8-20UNEF | 9.5 |
| 16 | 1-20UNEF | 52.37 | 19.05 | 31.75 | 7/8-20UNEF | 9.5 |
| 18 | 1 1/8-18UNEF | 52.37 | 19.05 | 34.14 | 1-20UNEF | 9.5 |
| 20 | 1 1/4-18UNEF | 55.58 | 19.05 | 37.31 | 1 3/16-18UNEF | 9.5 |
| 22 | 1 3/8-18UNEF | 55.58 | 19.05 | 40.49 | 1 3/16-18UNEF | 9.5 |
| 24 | 1 1/2-18UNEF | 58.72 | 20.62 | 43.66 | 1 7/16-18UNEF | 9.4 |
| 28 | 1 3/4-18UNEF | 58.72 | 20.62 | 50.01 | 1 7/16-18UNEF | 9.4 |
| 32 | 2-18UNEF | 61.93 | 22.23 | 56.36 | 1 3/4-18UNEF | 11.1 |
| 36 | 2 1/4-16UNEF | 61.93 | 22.23 | 62.71 | 2-18UNEF | 12.7 |
| 40 | 2 1/2-16UNEF | 61.93 | 22.23 | 69.06 | 2 1/4-18UNEF | 15.9 |

CABLE CONNECTING RECEPTACLE

AMS3101B



SOCKET



PIN PLUG

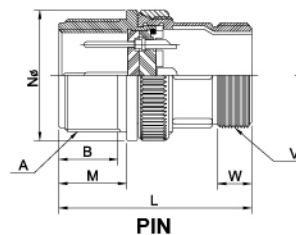
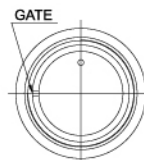

SOCKET

PIN

| Shell size | Coupling Threads A | Length of the effective portion of the thread over B | Length L | The length to the assembly rim M + 0.4 - 0 | Outer radius under N | Rear Threads V | Length of thread over W |
|------------|--------------------|--|----------|--|----------------------|------------------|-------------------------|
| 10SL | 5/8-24UNEF | 9.5 | 38.89 | 14.27 | 24.61 | 5/8-24UNEF | 9.5 |
| 12S | 3/4-20UNEF-2A | 9.5 | 42.88 | 14.3 | 26.97 | 5/8-24UNEF-2A | 9.5 |
| 14S | 7/8-20UNEF-2A | 9.5 | 42.88 | 14.3 | 29.36 | 3/4-20UNEF-2A | 9.5 |
| 16S | 1-20UNEF-2A | 9.5 | 42.88 | 14.3 | 31.75 | 7/8-20UNEF-2A | 9.5 |
| 16 | 1-20UNEF-2A | 15.9 | 52.37 | 19.0 | 31.75 | 7/8-20UNEF-2A | 9.5 |
| 18 | 1-1/8-18UNEF-2A | 15.9 | 52.37 | 19.0 | 34.14 | 1-20UNEF-2A | 9.5 |
| 20 | 1-1/4-18UNEF-2A | 15.9 | 55.58 | 19.0 | 37.31 | 1-3/16-18UNEF-2A | 9.5 |
| 22 | 1-3/8-18UNEF-2A | 15.9 | 55.58 | 19.0 | 40.49 | 1-3/16-18UNEF-2A | 9.5 |
| 24 | 1-1/2-18UNEF-2A | 15.9 | 58.72 | 19.0 | 43.66 | 1-7/16-18UNEF-2A | 9.5 |
| 28 | 1-3/4-18UNEF-2A | 15.9 | 58.72 | 19.0 | 50.01 | 1-7/16-18UNEF-2A | 9.5 |
| 32 | 2-18UNEF-2A | 15.9 | 61.93 | 19.0 | 56.36 | 1-3/4-18UNEF-2A | 11.1 |
| 36 | 2-1/4-16UNEF-2A | 15.9 | 61.93 | 19.0 | 62.71 | 2-18UNEF-2A | 12.7 |
| 48 | 3-16UNEF-2A | 15.9 | 65.07 | 15.9 | 81.76 | 3-16UNEF-2A | 15.9 |

PS. : Shell size and insert arrangement, please refer to page 2-3.

AMS3106A

STRAIGHT PLUG

IP 65

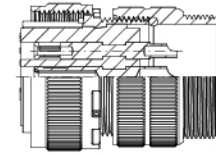
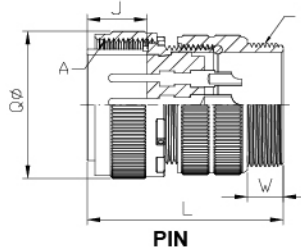
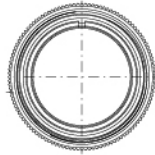

SOCKET

PIN

| Shell Size | Coupling Threads A | Full Length L | The length to the assembly rim J ± 0.3 | Outer radius Q ± 0.8 | Rear Threads V | Length of thread over W |
|------------|--------------------|---------------|--|----------------------|----------------|-------------------------|
| 10SL | 5/8-24UNEF | 38.89 | 13.49 | 24.61 | 5/8-24UNEF | 10 |
| 12s | 3/4-20UNEF | 42.88 | 13.49 | 26.97 | 5/8-24UNEF | 9.5 |
| 12 | 3/4-20UNEF | 52.37 | 18.26 | 26.97 | 5/8-24UNEF | 9.5 |
| 14s | 7/8-20UNEF | 42.88 | 13.49 | 29.36 | 3/4-20UNEF | 9.5 |
| 14 | 7/8-20UNEF | 52.37 | 18.26 | 29.36 | 3/4-20UNEF | 9.5 |
| 16s | 1-20UNEF | 42.88 | 13.49 | 31.75 | 7/8-20UNEF | 9.5 |
| 16 | 1-20UNEF | 52.37 | 18.26 | 31.75 | 7/8-20UNEF | 9.5 |
| 18 | 1 1/8-18UNEF | 52.37 | 18.26 | 34.14 | 1-20UNEF | 9.5 |
| 20 | 1 1/4-18UNEF | 55.58 | 18.26 | 37.31 | 1 3/16-18UNEF | 9.5 |
| 22 | 1 3/8-18UNEF | 55.58 | 18.26 | 40.49 | 1 3/16-18UNEF | 9.5 |
| 24 | 1 1/2-18UNEF | 58.72 | 18.26 | 43.66 | 1 7/16-18UNEF | 9.4 |
| 28 | 1 3/4-18UNEF | 58.72 | 18.26 | 50.01 | 1 7/16-18UNEF | 9.4 |
| 32 | 2-18UNEF | 61.93 | 18.26 | 56.36 | 1 3/4-18UNEF | 11.1 |
| 36 | 2 1/4-16UNEF | 61.93 | 18.26 | 62.71 | 2-18UNEF | 12.7 |
| 40 | 2 1/2-16UNEF | 61.93 | 18.26 | 69.06 | 2 1/4-18UNEF | 15.9 |

AMS3106B

STRAIGHT PLUG



SOCKET



PIN PLUG

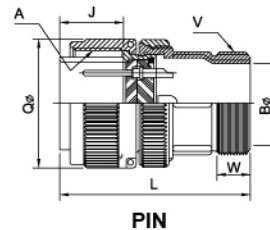
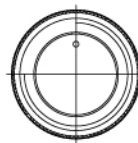

PIN

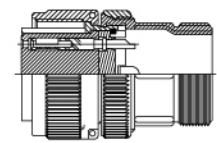

SOCKET

| Shell size | Coupling Threads A | Cable end B ± 0.3 | Length of connector J ± 0.3 | Full length | Outer radius Q ± 0.8 | Rear Threads V | Length of thread over W |
|------------|--------------------|-------------------|-----------------------------|-------------|----------------------|------------------|-------------------------|
| 10SL | 5/8-24UNEF-2B | 7.0 | 9.6 | 44.6 | 22.2 | 5/8-24UNEF-2A | 10.0 |
| 12S | 3/4-20UNEF-2B | 9.6 | 13.5 | 42.8 | 25.4 | 5/8-24UNEF-2A | 9.5 |
| 14S | 7/8-20UNEF-2B | 12.5 | 13.5 | 42.8 | 28.6 | 3/4-20UNEF-2A | 9.5 |
| 16S | 1-20UNEF-2B | 15.6 | 13.5 | 42.8 | 31.8 | 7/8-20UNEF-2A | 9.5 |
| 16 | 1-20UNEF-2B | 15.6 | 18.3 | 52.4 | 31.8 | 7/8-20UNEF-2A | 9.5 |
| 18 | 1-1/8-18UNEF-2B | 20.2 | 18.3 | 52.4 | 34.1 | 1-20UNEF-2A | 9.5 |
| 20 | 1-1/4-18UNEF-2B | 23.0 | 18.3 | 55.6 | 37.3 | 1-3/16-18UNEF-2A | 9.5 |
| 22 | 1-3/8-18UNEF-2B | 23.2 | 18.3 | 55.6 | 40.5 | 1-3/16-18UNEF-2A | 9.5 |
| 24 | 1-1/2-18UNEF-2B | 29.5 | 18.3 | 58.7 | 43.7 | 1-7/16-18UNEF-2A | 9.5 |
| 28 | 1-3/4-18UNEF-2B | 29.8 | 18.3 | 58.7 | 50.0 | 1-7/16-18UNEF-2A | 9.5 |
| 32 | 2-18UNEF-2B | 37.5 | 18.3 | 61.9 | 56.4 | 1-3/4-18UNEF-2A | 11.1 |
| 36 | 2-1/4-16UNEF-2B | 43.8 | 18.3 | 61.9 | 62.7 | 2-18UNEF-2A | 12.7 |
| 48 | 3-16UNEF-2B | 69.1 | 18.3 | 65.1 | 81.8 | 3-16UNEF-2A | 15.9 |

PS.: Shell size and insert arrangement, please refer to page 2-3

MIL-C-5015

STRAIGHT PLUG

WPS3106A



PIN PLUG



SOCKET INSERTION

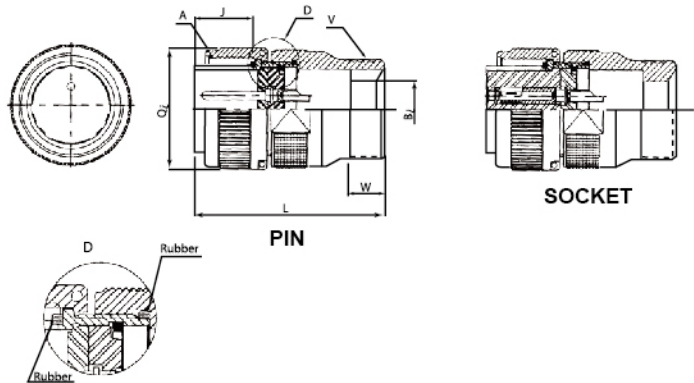

| Shell size (ps.1) | Coupling Threads A | Cable end B ± 0.3 | Length of connector J ± 0.3 | Full length | Outer radius Q ± 0.8 | Rear Threads V | Length of thread over W |
|-------------------|--------------------|-------------------|-----------------------------|-------------|----------------------|------------------|-------------------------|
| 10SL | 5/8-24UNEF-2B | 7 | 9.6 | 44.1 | 22 | 5/8-24UNEF-2A | 10 |
| 12S | 3/4-20UNEF-2B | 8.6 | 13.5 | 37.7 | 25.5 | 5/8-24UNEF-2A | 10 |
| 14S | 7/8-20UNEF-2B | 11 | 11.5 | 44 | 28.2 | 3/4-20UNEF-2A | 10 |
| 16S | 1-20UNEF-2B | 12 | 13.5 | 42.8 | 31.8 | 7/8-20UNEF-2A | 9.5 |
| 16 | 1-20UNEF-2B | 12 | 18.3 | 52.4 | 31.8 | 7/8-20UNEF-2A | 9.5 |
| 18 | 1-1/8-18UNEF-2B | 15 | 18.3 | 52.4 | 34.1 | 1-20UNEF-2A | 9.5 |
| 20 | 1-1/4-18UNEF-2B | 17 | 18.6 | 57.9 | 37.0 | 1-3/16-18UNEF-2A | 10.2 |
| 22 | 1-3/8-18UNEF-2B | 17 | 18.6 | 57.5 | 40.2 | 1-3/16-18UNEF-2A | 10.2 |
| 24 | 1-1/2-18UNEF-2B | 19 | 18.3 | 58.7 | 43.7 | 1-7/16-18UNEF-2A | 9.5 |
| 28 | 1-3/4-18UNS-2B | 21 | 18.3 | 58.7 | 50.0 | 1-7/16-18UNEF-2A | 9.5 |
| 32 | 2-18UNS-2B | 29 | 16.7 | 64 | 56 | 1-3/4-18UNS-2A | 9.5 |
| 36 | 2-1/4-18UNS-2B | 44.5 | 16.7 | 60.3 | 62 | 2-18UNS-2A | 9.5 |

PS.: Shell size and insert arrangement, please refer to page 2-3.

EUROPEAN STANDARD DIN VDE 0627

WPS3106A 18-10SE • WPS3106A 22-22SE

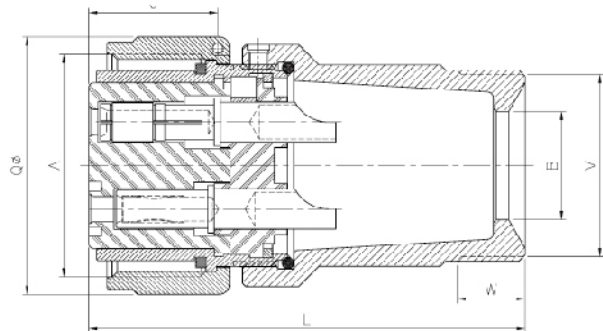

| Shell Size (ps.2) | Coupling Threads A | Cable end B ± 0.5 | Full length L ± 0.8 | M ± 0.8 | Outer radius Q ± 0.8 | Rear Threads V | Length of Threads over W | Length of Connect J ± 0.1 |
|-------------------|--------------------|-------------------|---------------------|---------|----------------------|------------------|--------------------------|---------------------------|
| WPS3106A 18-10SE | 1-1/8-18UNEF-2B | 15 | 57.4 | - | 34.1 | 1-20UNEF-2A | 10 | 18.7 |
| WPS3106A 22-22SE | 1-3/8-18UNEF-2B | 17 | 67.6 | - | 40.5 | 1-3/16-18UNEF-2A | 12.5 | 17.2 |

IP 65

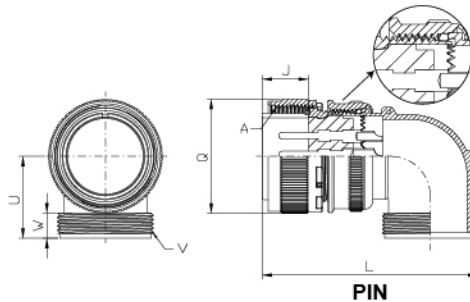

AMS3108A ANGLED PLUG

SOCKET

PIN

| Shell Size | Coupling Threads A | Full Length L | Length of connector J ± 0.3 | Outer radius Q ± 0.8 | U ± 0.8 | Rear Threads V | Length of thread over W |
|------------|--------------------|---------------|-----------------------------|----------------------|---------|----------------|-------------------------|
| 10SL | 5/8-24UNEF | 13.49 | 46.02 | 24.61 | 25.40 | 5/8-24UNEF | 10.5 |
| 12s | 3/4-20UNEF | 13.49 | 50.80 | 26.97 | 26.97 | 5/8-24UNEF | 9.5 |
| 12 | 3/4-20UNEF | 18.26 | 57.15 | 26.97 | 26.97 | 5/8-24UNEF | 9.5 |
| 14s | 7/8-20UNEF | 13.49 | 53.98 | 29.36 | 28.58 | 3/4-20UNEF | 9.5 |
| 14 | 7/8-20UNEF | 18.26 | 58.72 | 29.36 | 28.58 | 3/4-20UNEF | 9.5 |
| 16s | 1-20UNEF | 13.49 | 60.33 | 31.75 | 30.18 | 7/8-20UNEF | 9.5 |
| 16 | 1-20UNEF | 18.26 | 65.07 | 31.75 | 30.18 | 7/8-20UNEF | 9.5 |
| 18 | 1 1/8-18UNEF | 18.26 | 68.28 | 34.14 | 33.32 | 1-20UNEF | 9.5 |
| 20 | 1 1/4-18UNEF | 18.26 | 76.99 | 37.31 | 34.93 | 1 3/16-18UNEF | 9.5 |
| 22 | 1 3/8-18UNEF | 18.26 | 76.99 | 40.49 | 34.93 | 1 3/16-18UNEF | 9.5 |
| 24 | 1 1/2-18UNEF | 18.26 | 86.51 | 43.66 | 39.67 | 1 7/16-18UNEF | 9.5 |
| 28 | 1 3/4-18UNEF | 18.26 | 86.51 | 50.01 | 39.67 | 1 7/16-18UNEF | 9.5 |
| 32 | 2-18UNEF | 18.26 | 95.25 | 56.36 | 47.63 | 1 3/4-18UNEF | 11.1 |
| 36 | 2 1/4-16UNEF | 18.26 | 100.03 | 62.71 | 52.37 | 2-18UNEF | 12.7 |

AMS3108B ANGLED PLUG

ANGLED PLUG

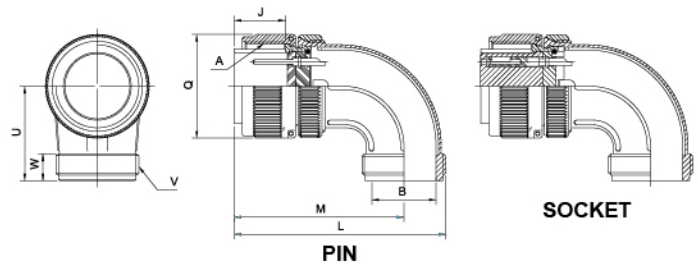

SOCKET

PIN PLUG

SOCKET

PIN

| Shell size (ps.2) | Coupling Threads A | Cable end B ± 0.3 | Length of connector J ± 0.3 | Full length L | M ± 0.8 | Outer radius Q ± 0.8 | U ± 0.8 | Rear Threads V | Length of thread over W |
|-------------------|--------------------|-------------------|-----------------------------|---------------|---------|----------------------|---------|------------------|-------------------------|
| 10SL | 5/8-24UNEF-2B | 7 | 9.6 | 44.6 | 37.6 | 22.2 | 24 | 5/8-24UNEF-2A | 10.5 |
| 12S | 3/4-20UNEF-2B | 9.6 | 13.5 | 50.8 | 41.7 | 25.4 | 25.4 | 5/8-24UNEF-2A | 9.5 |
| 14S | 7/8-20UNEF-2B | 12.5 | 13.5 | 54.0 | 43.3 | 28.6 | 27.0 | 3/4-20UNEF-2A | 9.5 |
| 16S | 1-20UNEF-2B | 15.6 | 13.5 | 60.3 | 48.0 | 31.8 | 28.6 | 7/8-20UNEF-2A | 9.5 |
| 16 | 1-20UNEF-2B | 15.6 | 18.3 | 65.1 | 52.8 | 31.8 | 28.6 | 7/8-20UNEF-2A | 9.5 |
| 18 | 1-1/8-18UNEF-2B | 18.6 | 18.3 | 68.3 | 54.4 | 34.1 | 32.1 | 1-20UNEF-2A | 9.5 |
| 20 | 1-1/4-18UNEF-2B | 23.0 | 18.3 | 77.0 | 60.7 | 37.3 | 33.7 | 1-3/16-18UNEF-2A | 9.5 |
| 22 | 1-3/8-18UNEF-2B | 23.2 | 18.3 | 77.0 | 60.7 | 40.5 | 33.3 | 1-3/16-18UNEF-2A | 9.5 |
| 24 | 1-1/2-18UNEF-2B | 29.6 | 28.0 | 18.3 | 86.5 | 67.1 | 43.7 | 1-7/16-18UNEF-2A | 9.5 |
| 28 | 1-3/4-18UNEF-2B | 29.8 | 28.2 | 18.3 | 86.5 | 67.1 | 50.0 | 1-7/16-18UNEF-2A | 9.5 |
| 32 | 2-18UNEF-2B | 35.9 | 18.3 | 95.2 | 71.8 | 56.4 | 46.4 | 1-3/4-18UNEF-2A | 11.1 |
| 36 | 2-1/4-16UNEF-2B | 42.7 | 42.2 | 18.3 | 100.0 | 73.4 | 62.7 | 2-18UNEF-2A | 12.7 |
| 48 | 3-16UNEF-2B | 69.1 | 65.9 | 18.3 | 125.4 | 86.5 | 81.8 | 3-16UNEF-2A | 15.9 |

PS. : Shell size and insert arrangement, please refer to page 2-3.

ANGLED PLUG

WPS3108A



PIN PLUG

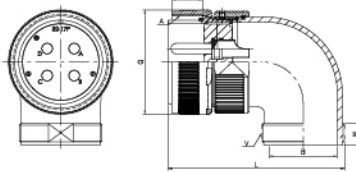

SOCKET

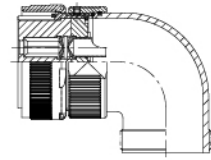

| Shell size (ps.1) | Coupling Threads A | Cable end B ± 0.3 | Length of connector J ± 0.3 | Full length | Outer radius Q ± 0.8 | Rear Threads V | Length of thread over W |
|-------------------|--------------------|-------------------|-----------------------------|-------------|----------------------|------------------|-------------------------|
| 10SL | 5/8-24UNEF-2B | 7 | 13.5 | 46 | 22.2 | 5/8-24UNEF-2A | 9.5 |
| 12S | 3/4-20UNEF-2B | 10.5 | 13.5 | 50.8 | 26.97 | 5/8-24UNEF-2A | 9.5 |
| 14S | 7/8-20UNEF-2B | 12.5 | 13.5 | 54 | 28.6 | 3/4-20UNEF-2A | 9.5 |
| 16 | 1-20UNEF-2B | 15.6 | 18.3 | 65.1 | 31.8 | 7/8-20UNEF-2A | 9.5 |
| 18 | 1-1/8-18UNEF-2B | 18.6 | 18.3 | 68.3 | 34.1 | 1-20UNEF-2A | 9.5 |
| 20 | 1-1/4-18UNEF-2B | 23.0 | 18.3 | 77 | 37.3 | 1-3/16-18UNEF-2A | 9.5 |
| 22 | 1-3/8-18UNEF-2B | 23.2 | 18.3 | 77 | 40.5 | 1-3/16-18UNEF-2A | 9.5 |
| 24 | 1-1/2-18UNEF-2B | 29.6 / 28.0 | 18.3 | 86.5 | 43.7 | 1-7/16-18UNEF-2A | 9.5 |
| 28 | 1-3/4-18UNS-2B | 29.8 / 28.2 | 18.3 | 86.5 | 50 | 1-7/16-18UNEF-2A | 9.5 |
| 32 | 2-18UNS-2B | 35.9 | 18.3 | 95.2 | 56.4 | 1-3/4-18UNS-2A | 11.1 |
| 36 | 2-1/4UN-2B | 43.8 / 42.2 | 18.3 | 100 | 62.7 | 2-18UNS-2A | 12.7 |

PS. : Shell size and insert arrangement, please refer to page 2-3.

EUROPEAN STANDARD DIN VDE 0627

WPS3108A 18-10SE • WPS3108A 22-22SE

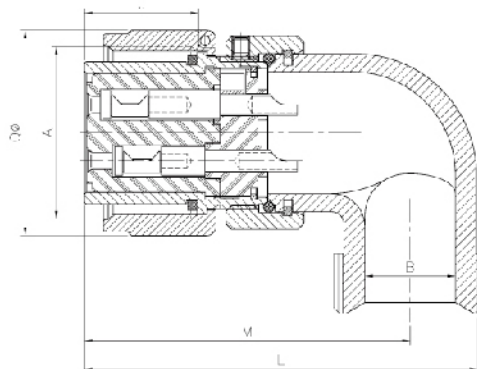

| Shell Size (ps.2) | Coupling Threads A | Cable end B ± 0.5 | Full length L ± 0.8 | M ± 0.8 | Outer radius Q ± 0.8 | Rear Threads V | Length of Threads over W | Length of Connector J ± 0.13 |
|-------------------|--------------------|-------------------|---------------------|---------|----------------------|------------------|--------------------------|------------------------------|
| WPS3108A 18-10SE | 1-1/8-18UNEF-2B | 15 | 57.4 | - | 34.1 | 1-20UNEF-2A | 10 | 18.7 |
| WPS3108A 22-22SE | 1-3/8-18UNEF-2B | 17 | 74 | - | 40.5 | 1-3/16-18UNEF-2A | 12.5 | 17.2 |

AMS3057-*A

CABLE CLAMP

AMS3057-*A type cable clamp is an accessory used for tightening the cables.

It is to be assembled with plug (3101B, 3106B, 3108B) and junction shell.

Clamping shall be based upon the clamp saddle from two sides. It is attached with clipper and it is able to fix it evenly and accurately.

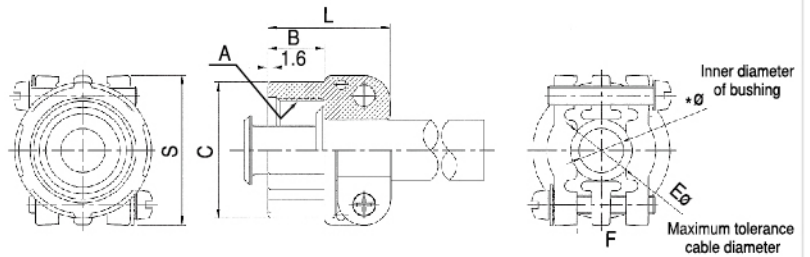

| Item No. | Shell size (ps.1) | Bushing item AMS3420 | Coupling Threads A | B | Max. Tolerable cable $C\phi \pm 0.41$ | Cable Clamp E | F | Length $L \pm 0.8$ | $S + 0.8$ | Content ϕ |
|-------------|-------------------|----------------------|--------------------|------|---------------------------------------|---------------|------|--------------------|-----------|----------------|
| AMS3057-4A | 12S | -4 | 5/8-24UNEF-2B | 10.3 | 20.6 | 7.9 | 1.6 | 20.6 | 22.2 | 6 |
| AMS3057-6A | 14S | -6 | 3/4-20UNEF-2B | 10.3 | 24.6 | 11.1 | 2.0 | 22.2 | 27.0 | 8 |
| AMS3057-8A | 16S, 16 | -8 | 7/8-20UNEF-2B | 10.3 | 27.8 | 14.3 | 2.8 | 23.8 | 29.4 | 11 |
| AMS3057-10A | 18 | -10 | 1-20UNEF-2B | 10.3 | 30.2 | 15.9 | 3.2 | 23.8 | 31.8 | 14 |
| AMS3057-12A | 20, 22 | -12 | 1-3/16-18UNEF-2B | 10.3 | 34.9 | 19.0 | 4.0 | 23.8 | 37.3 | 16 |
| AMS3057-16A | 24, 28 | -12, -16 | 1-7/16-18UNEF-2B | 10.3 | 42.1 | 23.8 | 4.8 | 26.2 | 42.9 | 16 |
| AMS3057-20A | 32 | -16, -20 | 1-3/4-18UNS-2B | 11.9 | 51.2 | 31.8 | 6.4 | 27.8 | 51.6 | 19 |
| AMS3057-24A | 36 | -20, -24 | 2-18UNS-2B | 13.5 | 56.4 | 34.9 | 7.5 | 29.4 | 57.9 | 24 |
| AMS3057-40A | 48 | -28, -32, -40 | 3-16UN-2B | 16.7 | 83.3 | 60.3 | 11.5 | 44.4 | 88.9 | 35 |

RE: SELECTION OF COMMODITY NAME

(a) Please refer to the column of "Suitable shell size" Please select the commodity names suitable for the shell size of the connector.

Example: For connector AMS3106 18-1P, because the shell size is 18, the commodity name of cable clamp shall be AMS3057-10A

(b) The maximum size of the cable used in clamping, Please make sure if it is in conformity with the sizes shown in above table.

AMS3420

BUSHING

MS3420 rubber bushing is an accessory and it is used for installation of AMS3057A cable clamp, in case that the cable clamp is not operational while bundling the cables.

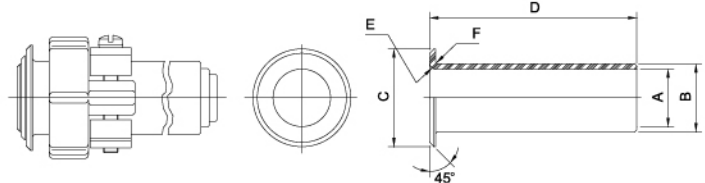

The status of the rubber bushing assembled on AMS3057A cable clamp

| Item No. | Inner Diameter $A\phi \pm 0.41$ | Out Diameter $B\phi \pm 0.41$ | $C\phi \pm 0.41$ | Length $D \pm 0.8$ | $Fr, Fr \pm 0.8$ |
|-----------|---------------------------------|-------------------------------|------------------|--------------------|------------------|
| MS3420-3 | 3.30 | 5.33 | 9.63 | 73.0 | 0.8 |
| MS3420-4 | 5.59 | 7.67 | 12.83 | 69.8 | 0.8 |
| MS3420-6 | 7.92 | 10.85 | 15.72 | 66.7 | 0.8 |
| MS3420-8 | 11.10 | 14.02 | 18.90 | 63.5 | 1.6 |
| MS3420-10 | 14.27 | 15.62 | 22.07 | 60.3 | 1.6 |
| MS3420-12 | 15.88 | 18.80 | 27.03 | 57.2 | 1.6 |
| MS3420-16 | 19.05 | 23.55 | 33.38 | 54.0 | 1.6 |
| MS3420-20 | 23.80 | 31.50 | 40.54 | 50.8 | 1.6 |
| MS3420-24 | 31.75 | 34.67 | 46.91 | 47.6 | 1.6 |
| MS3420-28 | 34.92 | 41.00 | 52.96 | 44.4 | 1.6 |
| MS3420-32 | 41.25 | 47.35 | 59.31 | 41.3 | 1.6 |
| MS3420-40 | 47.60 | 60.05 | 72.01 | 38.1 | 1.6 |

MIL-C-5015

CABLE CLAMP

WPS3057-*A

 IP65

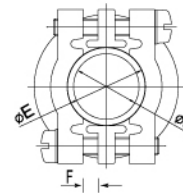
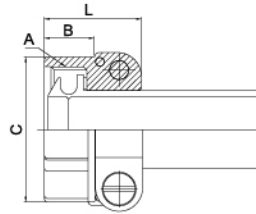
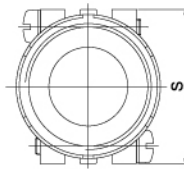

| Item No. | Shell size (ps.1) | Coupling Threads A | B | Tolerable cable C $\varnothing \pm 0.41$ | Clamp E | F | Length L ± 0.8 | S + 0.8 | Content \varnothing |
|-------------|-------------------|--------------------|------|--|---------|------|--------------------|---------|-----------------------|
| WPS3057-4A | 10S, 12S | 5/8-24UNEF-2B | 10.3 | 20.6 | 7.7 | 2 | 20.7 | 22.2 | 6.6 |
| WPS3057-6A | 14S | 3/4-20UNEF-2B | 10.3 | 24.6 | 10.8 | 2.8 | 22.2 | 27.1 | 8 |
| WPS3057-8A | 16S, 16 | 7/8-20UNEF-2B | 10.3 | 27.8 | 14.3 | 2.8 | 23.8 | 29.4 | 11 |
| WPS3057-10A | 18 | 1-20UNEF-2B | 10.3 | 30.2 | 15.9 | 3.2 | 23.8 | 31.8 | 14 |
| WPS3057-12A | 20, 22 | 1-3/16-18UNEF-2B | 10.3 | 34.9 | 19.8 | 4.0 | 23.8 | 37.3 | 16 |
| WPS3057-16A | 24, 28 | 1-7/16-18UNEF-2B | 10.3 | 42.1 | 23.8 | 4.8 | 26.2 | 42.9 | 19 |
| WPS3057-20A | 32 | 1-3/4-18UNS-2B | 11.9 | 51.2 | 31.8 | 6.4 | 27.8 | 51.6 | 19 |
| WPS3057-24A | 36 | 2-18UNS-2B | 13.5 | 56.4 | 34.9 | 7.5 | 29.4 | 57.9 | 24 |
| WPS3057-40A | 48 | 3-16UN-2B | 16.7 | 83.3 | 60.3 | 11.5 | 44.4 | 88.9 | 35 |

RE: SELECTION OF COMMODITY NAME

- (a) Please refer to the column of "Suitable shell size". Please select the commodity names suitable for the shell size of the connector.
Example: For connector WPS3106A 18-1P, because the shell size is 18, the commodity name of cable clamp shall be WPS3057-10A
- (b) Please make sure if it is in conformity with the sizes shown in above table.

BUSHING

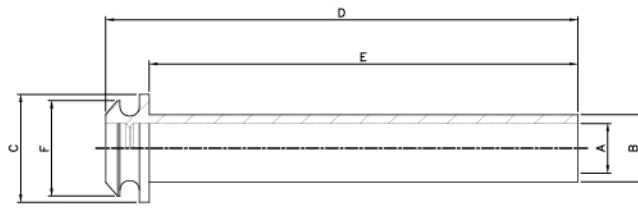
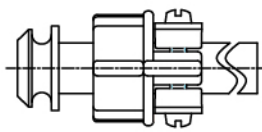

The status of the rubber bushing assembled on WPS3057A cable clamp

| Item No. | Inner Diameter A $\varnothing \pm 0.3$ | Out Diameter B $\varnothing \pm 0.3$ | C $\varnothing \pm 0.3$ | Length D ± 0.8 | Length E ± 0.3 | F $\varnothing \pm 0.3$ |
|---------------|--|--------------------------------------|-------------------------|--------------------|--------------------|-------------------------|
| H-156RX (4A) | 6 | 7.6 | 13 | 47.5 | 40.8 | 12 |
| H-226RXB (6A) | 8 | 10.85 | 17.4 | 72.7 | 66 | 15.4 |
| H-372RXB (8A) | 11.1 | 14 | 20 | 72.5 | 63.5 | 18 |
| H-153RX (10A) | 14 | 15.6 | 22 | 52.1 | 44 | 21.2 |
| H-098RX (12A) | 15.88 | 18.88 | 26 | 52 | 43.4 | 25 |
| H-152RX (16A) | 18 | 23 | 33 | 56.2 | 46.4 | 30.4 |
| H-371RB (20A) | 23.85 | 31.5 | 41 | 61.4 | 50.8 | 36 |

AMS25042-**D

CAP AND CHAIN ASSEMBLY

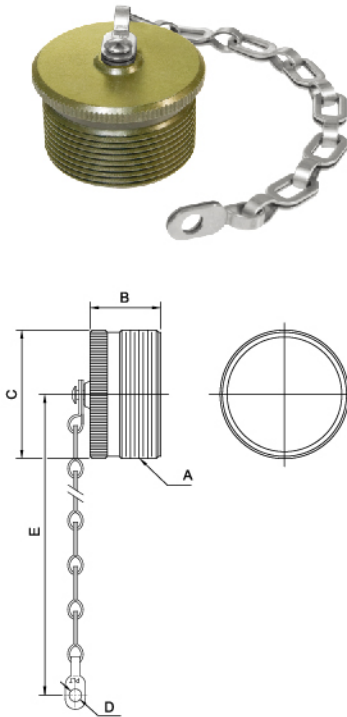

| Part Number | Shell size | Threads A | B | C | D | E |
|--------------|------------|---------------|----------------|-----------------|---------------|------------------|
| AMS25042-10D | 10S | 5/8-24UNEF-2A | .815 (20.7) | .625 (15.9) | .177 (4.5) | 6.055 (153.8) |
| AMS25042-12D | 12S | 3/4-20UNEF | .815 (20.7) | .752 (19.1) | .154 (3.9) | 4.488 (114) |
| AMS25042-14D | 14S | 7/8-20UNEF | .815 (20.7) | .874 (22.2) | .154 (3.9) | 4.488 (114) |
| AMS25042-16D | 16S, 16 | 1-20UNEF | .815 (20.7) | 1.000 (25.4) | .154 (3.9) | 4.488 (114) |
| AMS25042-18D | 18 | 1-1/8-18UNEF | .815 (20.7) | 1.126 (28.6) | .154 (3.9) | 4.488 (114) |
| AMS25042-20D | 20 | 1-1/4-18UNEF | .815 (20.7) | 1.252 (31.8) | .185 (4.7) | 5.000 (127) |
| AMS25042-22D | 22 | 1-3/8-18UNEF | .815 (20.7) | 1.374 (34.9) | .185 (4.7) | 5.000 (127) |
| AMS25042-24D | 24 | 1-1/2-18UNEF | .815 (20.7) | 1.500 (38.1) | .185 (4.7) | 5.472 (139) |
| AMS25042-28D | 28 | 1-3/4-18UNS | .815 (20.7) | 1.752 (44.5) | .185 (4.7) | 7.480 (190) |
| AMS25042-32D | 32 | 2-18UNS | .815 (20.7) | 2.000 (50.8) | .217 (5.5) | 7.480 (190) |
| AMS25042-36D | 36 | 2-1/4-16UN | .815 (20.7) | 2.252 (57.2) | .217 (5.5) | 7.480 (190) |

AMS25043-**D

CAP AND CHAIN ASSEMBLY

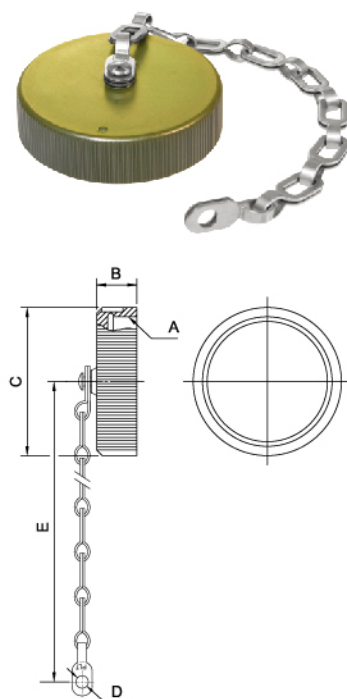

| Part Number | Shell size | Threads A | B | C | D | E |
|--------------|------------|---------------|----------------|-----------------|---------------|------------------|
| AMS25043-10D | 10S | 5/8-24UNEF-2B | .437 (11.1) | .787 (20.0) | .177 (4.5) | 6.055 (153.8) |
| AMS25043-12D | 12S | 3/4-20UNEF | .437 (11.1) | .874 (22.2) | .138 (3.5) | 4.488 (114) |
| AMS25043-14D | 14S | 7/8-20UNEF | .437 (11.1) | 1.000 (25.4) | .138 (3.5) | 4.488 (114) |
| AMS25043-16D | 16S, 16 | 1-20UNEF | .437 (11.1) | 1.157 (29.4) | .138 (3.5) | 4.488 (114) |
| AMS25043-18D | 18 | 1-1/8-18UNEF | .437 (11.1) | 1.252 (31.8) | .138 (3.5) | 4.488 (114) |
| AMS25043-20D | 20 | 1-1/4-18UNEF | .437 (11.1) | 1.374 (34.9) | .138 (3.5) | 5.000 (127) |
| AMS25043-22D | 22 | 1-3/8-18UNEF | .437 (11.1) | 1.500 (38.1) | .138 (3.5) | 5.000 (127) |
| AMS25043-24D | 24 | 1-1/2-18UNEF | .500 (12.7) | 1.689 (42.9) | .138 (3.5) | 5.472 (139) |
| AMS25043-28D | 28 | 1-3/4-18UNS | .500 (12.7) | 1.921 (48.8) | .169 (4.3) | 7.480 (190) |
| AMS25043-32D | 32 | 2-18UNS | .500 (12.7) | 2.189 (55.6) | .185 (4.7) | 7.480 (190) |
| AMS25043-36D | 36 | 2-1/4-16UN | .500 (12.7) | 2.437 (61.9) | .185 (4.7) | 7.480 (190) |

MIL-C-5015

CABLE CLAMP

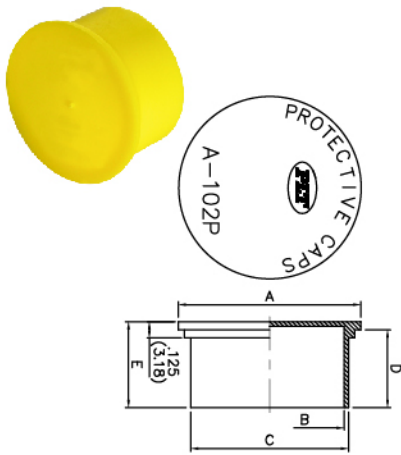

| Part Number | A | B | C | D | E |
|-------------|-------------|-------------|------------|------------|------------|
| A-097P | .748(19.0) | .531(13.5) | .748(19.0) | .626(15.9) | .661(16.8) |
| A-098P | .858(21.8) | .654(16.6) | .748(19.0) | .626(15.9) | .661(16.8) |
| A-099P | 1.031(26.2) | .783(19.9) | .748(19.0) | .626(15.9) | .661(16.8) |
| A-100P | 1.126(28.6) | .894(22.7) | .748(19.0) | .626(15.9) | .661(16.8) |
| A-101P | 1.248(31.7) | 1.024(26.0) | .748(19.0) | .626(15.9) | .661(16.8) |
| A-102P | 1.406(35.7) | 1.150(29.2) | .748(19.0) | .626(15.9) | .661(16.8) |
| A-103P | 1.500(38.1) | 1.272(32.3) | .748(19.0) | .626(15.9) | .661(16.8) |
| A-104P | 1.642(41.7) | 1.390(35.3) | .748(19.0) | .626(15.9) | .661(16.8) |
| A-105P | 1.874(47.6) | 1.650(41.9) | .748(19.0) | .626(15.9) | .661(16.8) |
| A-106P | 2.126(54.0) | 1.890(48.0) | .748(19.0) | .626(15.9) | .661(16.8) |
| A-107P | 2.339(59.4) | 2.142(54.4) | .748(19.0) | .626(15.9) | .661(16.8) |

PROTECTIVE CAPS

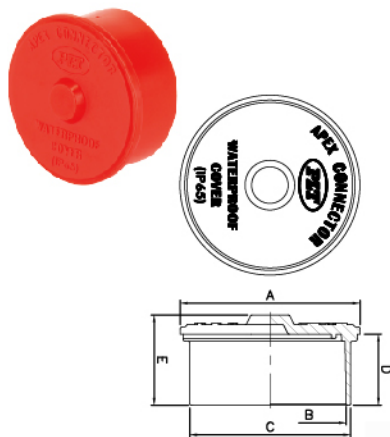

| Part Number | A | B | C | D | E |
|-------------|-------------|-------------|-------------|------------|------------|
| A-097R | .839(21.3) | .606(15.4) | .665(16.9) | .500(12.7) | .535(13.6) |
| A-098R | .969(24.6) | .720(18.3) | .776(19.7) | .500(12.7) | .535(13.6) |
| A-099R | 1.126(28.6) | .850(21.6) | .906(23.0) | .500(12.7) | .535(13.6) |
| A-100R | 1.220(31.0) | .972(24.7) | 1.035(26.3) | .500(12.7) | .535(13.6) |
| A-101R | 1.331(33.8) | 1.094(27.8) | 1.154(29.3) | .563(14.3) | .598(15.2) |
| A-102R | 1.465(37.2) | 1.232(31.3) | 1.299(33.0) | .563(14.3) | .598(15.2) |
| A-103R | 1.591(40.4) | 1.339(34.0) | 1.409(35.8) | .563(14.3) | .598(15.2) |
| A-104R | 1.701(43.2) | 1.465(37.0) | 1.531(38.9) | .563(14.3) | .598(15.2) |
| A-105R | 1.949(49.5) | 1.717(43.6) | 1.791(45.5) | .563(14.3) | .598(15.2) |
| A-106R | 2.220(56.4) | 1.965(49.9) | 2.039(51.8) | .563(14.3) | .598(15.2) |
| A-107R | 2.443(61.8) | 2.217(56.3) | 2.291(58.2) | .598(15.2) | .634(16.1) |

TYPES AND SIZES REQUIRED

AMS3101

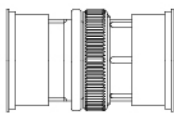

AMS3102

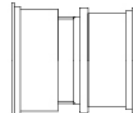

AMS3106

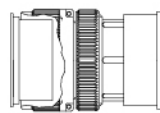

AMS3108

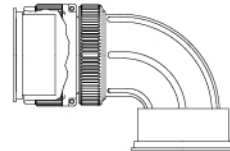

| Shell size | Mating End | Termination End | Mating End | Termination End | Mating End | Termination End | Mating End | Termination End |
|------------|------------|-----------------|------------|-----------------|------------|-----------------|------------|-----------------|
| 12S | A-097R | A-097R | A-098R | | A-098P | A-097R | A-098P | A-097R |
| 14S | A-099R | A-098R | A-099R | A-098R | A-099P | A-098R | A-099P | A-098R |
| 16S, 16 | A-101R | A-099R | A-100R | A-099R | A-100P | A-099R | A-100P | A-099R |
| 18 | A-103R | A-100R | A-101R | A-100R | A-101P | A-100R | A-101P | A-100R |
| 20 | A-105R | A-102R | A-102R | A-101R | A-102P | A-102R | A-102P | A-102R |
| 22 | A-107R | A-102R | A-103R | A-102R | A-103P | A-102R | A-103P | A-102R |
| 24 | A-109R | | A-104R | A-103R | A-104P | | A-104P | |
| 28 | A-111R | | A-105R | | A-105P | | A-105P | |
| 32 | A-113R | A-105R | A-106R | | A-106P | A-105R | A-106P | A-105R |
| 36 | A-115R | A-106R | A-107R | | A-107P | A-106R | A-107P | A-106R |

WPS3106A 18-10SA-R • WPS3101A 18-10PA-R

IP67

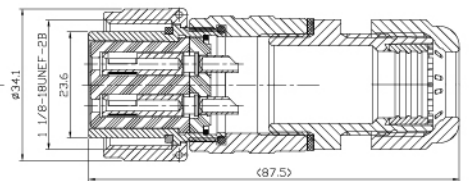
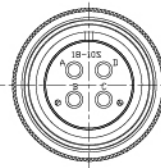
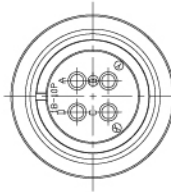
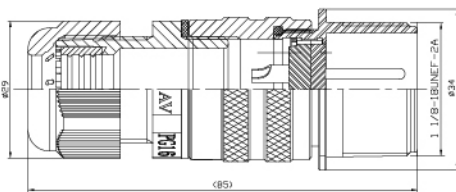

WPS3106A 18-1SA-R • WPS3101A 18-1PA-R

IP67

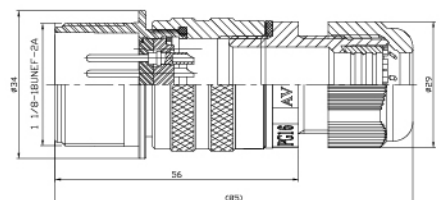
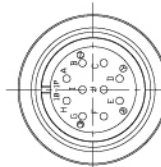
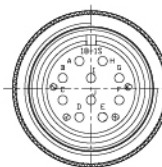
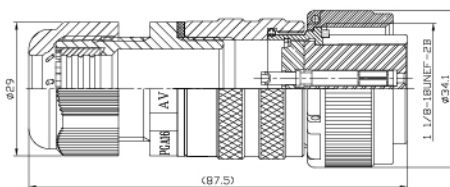

No. ELECTRICAL SPECIFICATIONS

| | | | |
|---|---------------------------------|--------------|------|
| 1 | Test Current (Amperes) | | 13 |
| 2 | Operating voltage (V.) | DC.V | 700 |
| | | AC.V (r.m.s) | 500 |
| 3 | Withstanding voltage (V.) | | 2000 |
| 4 | Insulation resistance (MΩ MIN.) | | 5000 |

AMS3106A ACGS17-18-10S-RA-R

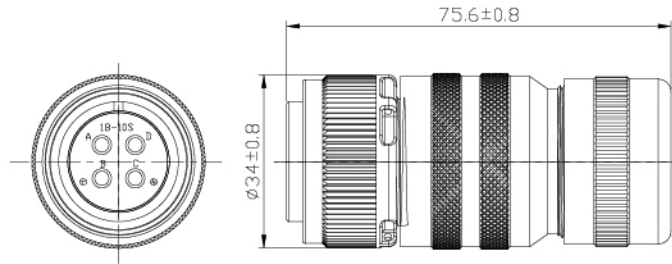

AMS3108A ACGB17-18-10S-RA-R

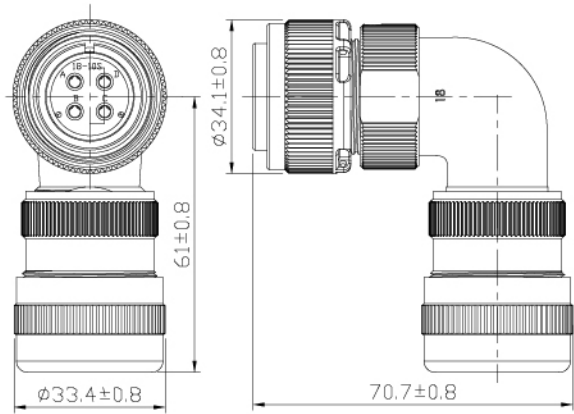

| No. | ELECTRICAL CHARACTERISTICS | |
|-----|----------------------------|------------------------|
| 1 | Withstanding voltage | AC : 2000V / 1 MINUTE |
| 2 | Insulation resistance | 5000MΩ min. AT DC 500V |
| 3 | Contact Resistance | DC 1A MAX 3mΩ |

WPS3106F 14S 2S-R

IP65

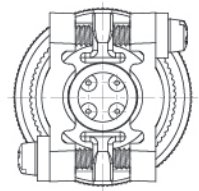
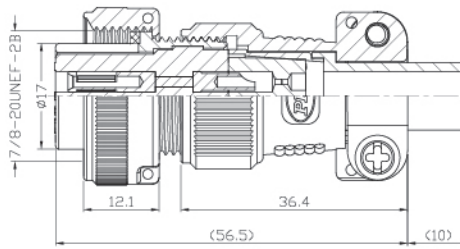
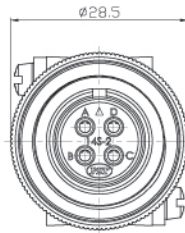

No. ELECTRICAL SPECIFICATIONS

| | | |
|---|-----------------------|------------------------|
| 1 | Withstanding voltage | AC : 2000V / 1 MINUTE |
| 2 | Insulation resistance | 5000MΩ min. AT DC 500V |

WPS3106A 18-10 SEA-R

IP67

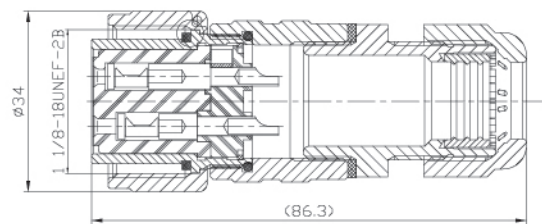
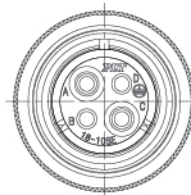

No. ELECTRICAL SPECIFICATIONS

| | | |
|---|-----------------------|------------------------|
| 1 | Withstanding voltage | AC : 2800V / 1 MINUTE |
| 2 | Insulation resistance | 5000MΩ min. AT DC 500V |

AMS3126A 16-26P-R • AMS3126A 16-26 SA-R

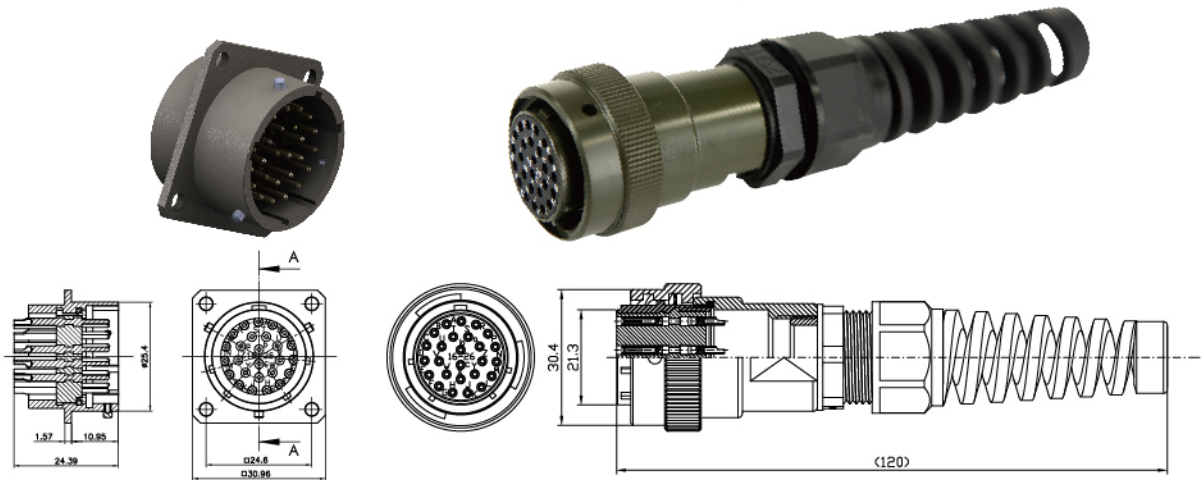

AMS3122E 16-26A

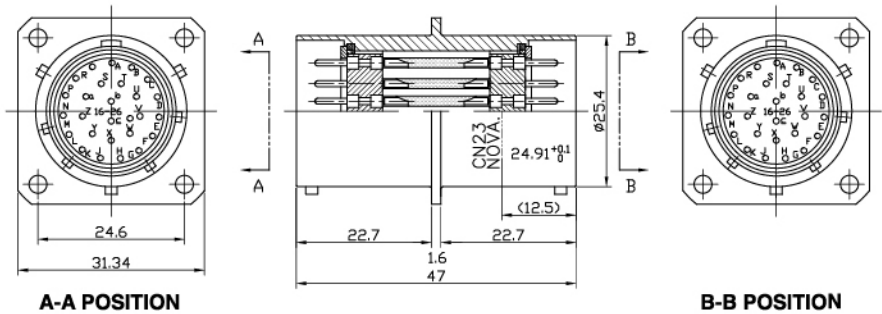

AMS3126A 16-26S

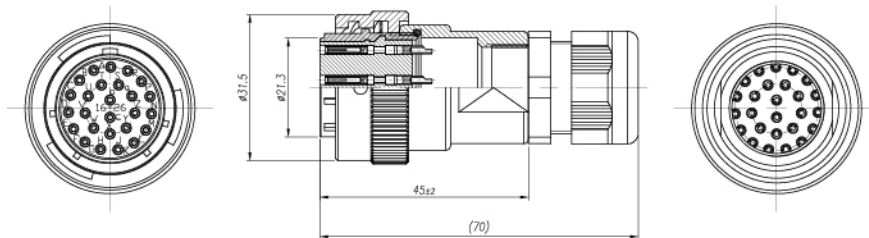

No. ELECTRICAL CHARACTERISTICS

| | | |
|---|-------------------------------------|-------------|
| 1 | Rated Current / voltage | 5A 125V |
| 2 | Operation limit voltage (rms) | 200V AC |
| 3 | Withstanding voltage (rms 1 minute) | 1000V AC |
| 4 | Insulation resistance (at DC 500V) | 1000MΩ MIN. |
| 5 | Contact resistance (at DC 1A) | 3mΩ MAX. |

WPS3112E • WPS3116A



#20x8 PIN CONNECTOR



#20x8 PIN CONNECTOR

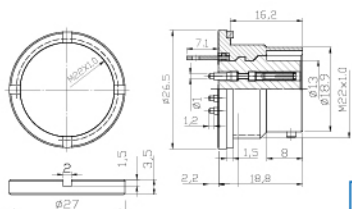

WPS3112E 12-3S

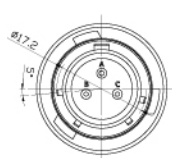

WPS3116A 12-3P

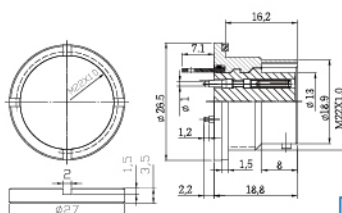
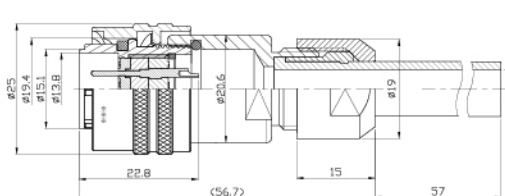

WPS3112E 12-8S

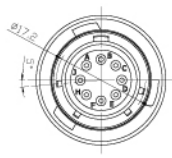

WPS3116A 12-8P

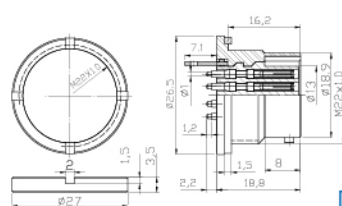
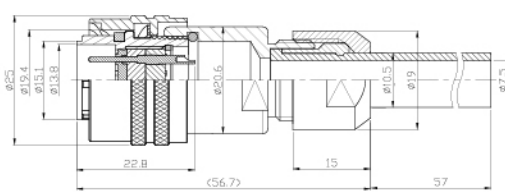

WPS3112E 12-14S

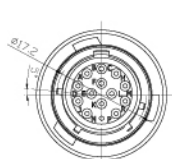

WPS3116A 12-14P

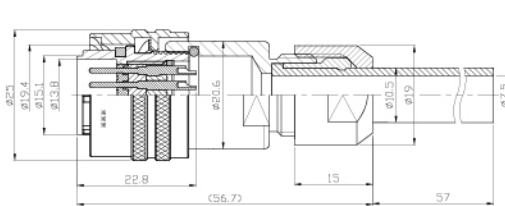

No. ELECTRICAL CHARACTERISTICS

| | | |
|---|---|---------|
| 1 | Rated Current / voltage | 5A 125V |
| 2 | Operation limit voltage (AC.V.rms) | 200 |
| 3 | Withstanding voltage (AC.V.rms) 1 minute | 1000 |
| 4 | Insulation resistance(MΩ MIN.) at DC 500V | 1000 |
| 5 | Contact resistance (mΩ MAX.) at DC 1A | 3 |

WPS3118A

IP65



#20x8 PIN CONNECTOR

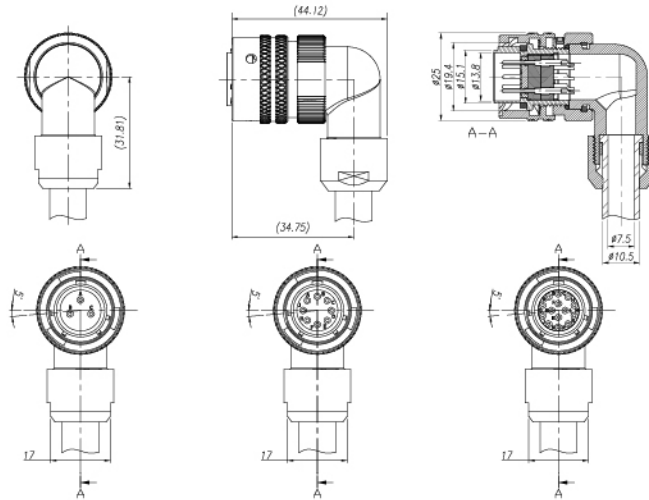

WPS3118A 12-3P

WPS3118A 12-8P

WPS3118A 12-14P

WPS3111A

IP65



#20x14 PIN CONNECTOR

WPS3111A 12-3S



WPS3111A 12-8S

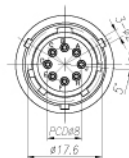

WPS3111A 12-14S

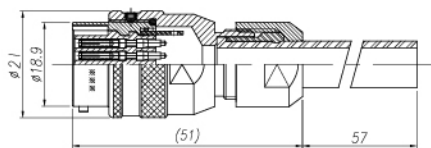
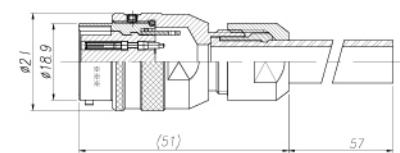
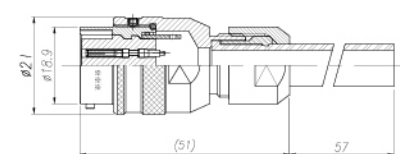
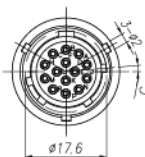

No. ELECTRICAL CHARACTERISTICS

| | | |
|---|---|---------|
| 1 | Rated Current / voltage | 5A 125V |
| 2 | Operation limit voltage (AC.V.rms) | 200 |
| 3 | Withstanding voltage (AC.V.rms) 1 minute | 1000 |
| 4 | Insulation resistance(MΩ MIN.) at DC 500V | 1000 |
| 5 | Contact resistance (mΩ MAX.) at DC 1A | 3 |

MIL-DTL-26482

WPS3112E 8-3PA-R • WPS3116E 8-3S

IP 65



開發中
DEVELOPING

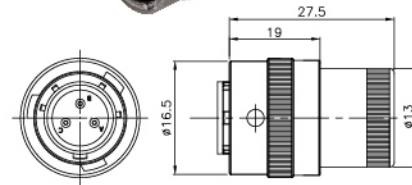
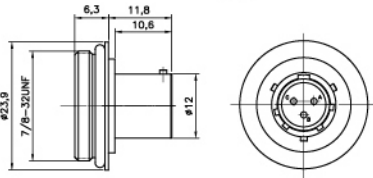

WPS3112E 10-6P • WPS3116E 10-6S

IP 65

開發中
DEVELOPING



開發中
DEVELOPING

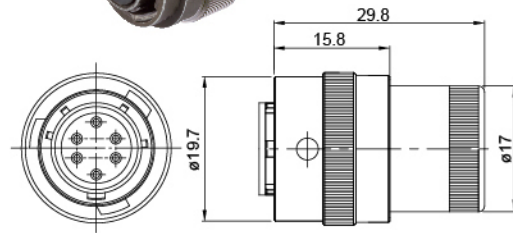
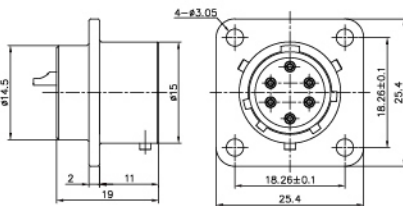

WPS3112E 12-10S • WPS3116E 12-10PA-R

IP 65

開發中
DEVELOPING



開發中
DEVELOPING

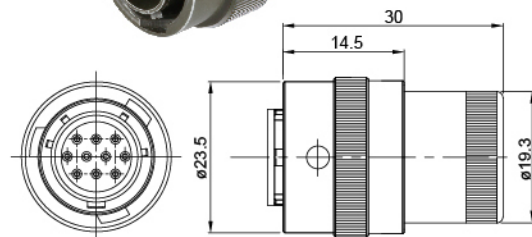
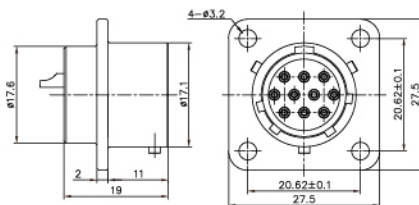

| No | ELECTRICAL CHARACTERISTICS | |
|----|---|---------|
| 1 | Rated Current / voltage | 5A 125V |
| 2 | Operation limit voltage (AC.V.rms) | 200 |
| 3 | Withstanding voltage (AC.V.rms) 1 Minute | 1000 |
| 4 | Insulation resistance (MΩ MIN.) at DC 500V | 1000 |
| 5 | Contact resistance (mΩ MAX.) at DC 1A | 3 |

MIL-DTL-26482

WPM-3285-RM

IP67

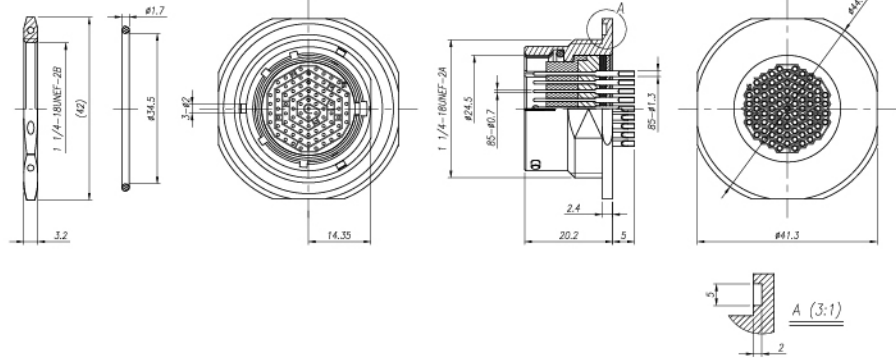

OTHERS

WPM-3285-RFY

IP67

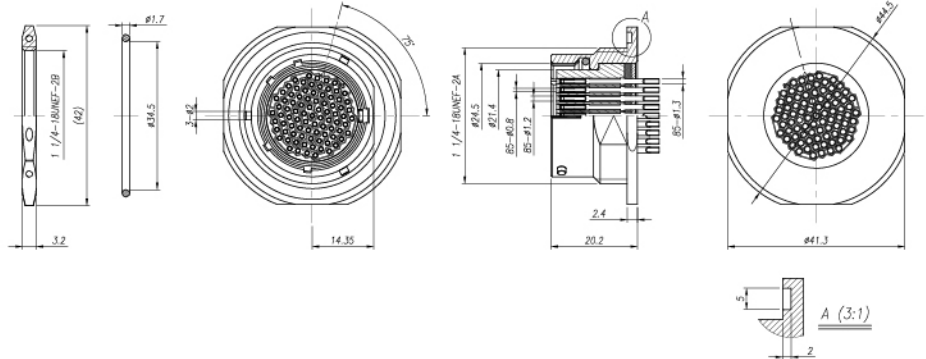

| No. | ELECTRICAL CHARACTERISTICS | |
|-----|-------------------------------------|-------------|
| 1 | Rate Current / voltage | 5A 125V |
| 2 | Operation limit voltage (rms) | 200V AC |
| 3 | Withstanding voltage (rms 1 minute) | 1000V AC |
| 4 | Insulation resistance (at DC 500V) | 1000MΩ MIN. |
| 5 | Contact resistance (at DC 1A) | 3mΩ MAX. |

AMS3102R • AMS3106M

 IP65

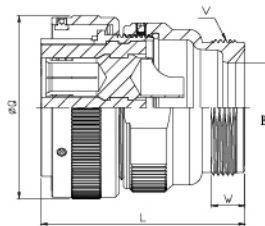
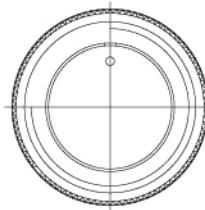
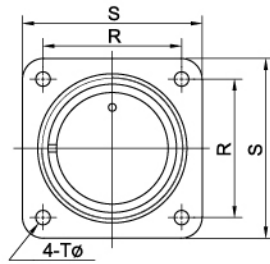
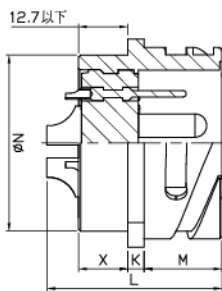

• AMS3102R

| Shell Size | Thickness of the assembly rim under K | Length L | Length of assembly rim M +0.79 - 0 | Outer radius of the terminal M + 0 - 4.78 | Position of the holes reserved for assembly R ± 0.13 | Length of the protruded sides S ± 0.79 | Hole diameter of the assembly holes T +0.25 - 0.13 |
|------------|---------------------------------------|----------|--|---|---|---|--|
| 24 | 3.0 | 33.4 | 20.62 | 38.91 | 34.92 | 44.45 | 3.73 |
| 28 | 3.0 | 33.4 | 20.62 | 45.26 | 39.67 | 50.80 | 3.73 |
| 32 | 4.3 | 33.4 | 22.22 | 51.26 | 44.45 | 57.15 | 4.39 |
| 36 | 4.3 | 33.4 | 22.22 | 57.96 | 49.23 | 63.50 | 4.39 |
| 48 | 4.3 | 33.2 | 22.22 | 77.90 | 66.68 | 82.55 | 4.39 |

• AMS3106M

| Shell Size | Cable end B ± 0.3 | Length L | Rear Threads V | Length of thread over W |
|------------|----------------------|----------|------------------|-------------------------|
| 24 | 29.5 | 58.72 | 1-7/16-18UNEF-2A | 9.5 |
| 28 | 29.8 | 58.72 | 1-7/16-18UNEF-2A | 9.5 |
| 32 | 37.5 | 61.93 | 1-3/4-18UNEF-2A | 11.1 |
| 36 | 43.8 | 61.93 | 2-18UNS-2A | 12.7 |
| 48 | 69.1 | 65.07 | 3-16UN-2A | 15.9 |

AMS3108M

 IP65

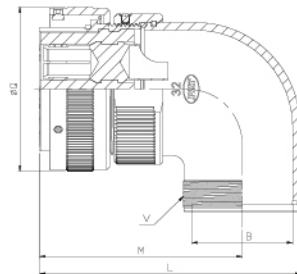
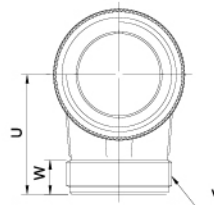

| Shell size (ps.2) | Cable end B ± 0.3 | Full length L | M ± 0.8 | Outer radius Q ± 0.8 | U ± 0.8 | Rear Treads V | Length of tread over W |
|-------------------|----------------------|---------------|---------|-------------------------|---------|------------------|------------------------|
| 24 | 29.6 / 28.0 | 86.5 | 67.1 | 43.7 | 34.9 | 1-7/16-18UNEF-2A | 9.5 |
| 28 | 29.8 / 28.2 | 86.5 | 67.1 | 50.0 | 38.5 | 1-7/16-18UNEF-2A | 9.5 |
| 32 | 35.9 | 95.2 | 71.8 | 56.4 | 46.4 | 1-3/4-18UNEF-2A | 11.1 |
| 36 | 42.7 / 42.2 | 100.0 | 73.4 | 62.7 | 51.2 | 2-18UNS-2A | 12.7 |
| 48 | 69.1 / 65.9 | 125.4 | 86.5 | 81.8 | 59.1 | 3-16UN-2A | 15.9 |

AMS17344R 32C-17S • AMS17346R 32C-17P

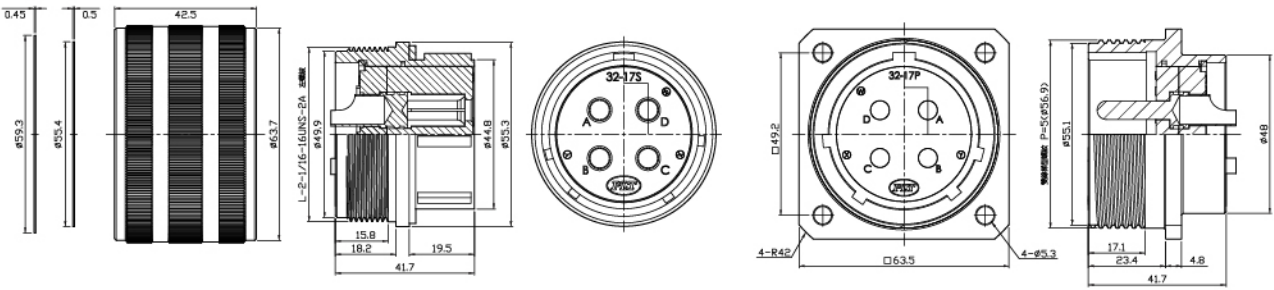

OTHERS

AMS17349C32B

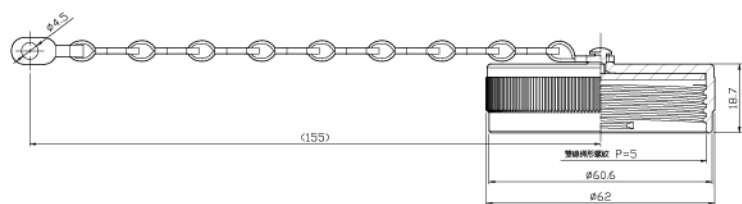

| No. | ELECTRICAL SPECIFICATIONS | |
|-----|---------------------------|--------------------------------|
| 1 | Withstanding voltage | AC : 2800V/ 1 MINUTE |
| 2 | Test Current | <u>80</u> AMPERES |
| 3 | Insulation resistance | 5000M Ω min. AT DC 500V |

WPS3102F 22-2P-R • WPS3106F 22-2S-R

IP65

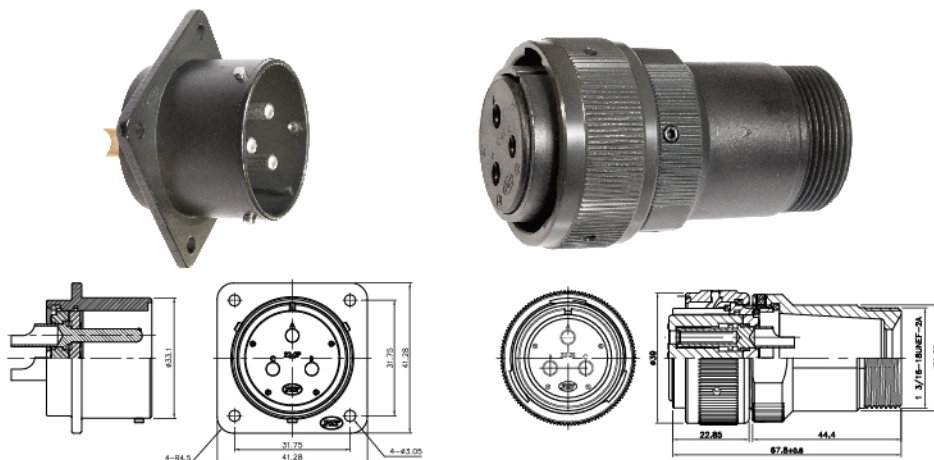

| No. | ELECTRICAL SPECIFICATIONS | |
|-----|---------------------------|-----------------------|
| 1 | Withstanding voltage | AC:2800V/1MINUTE |
| 2 | Insulation resistance | 5000MΩ min.AT DC 500V |

WPS3102B 28-18S • WPS3106B 28-18P

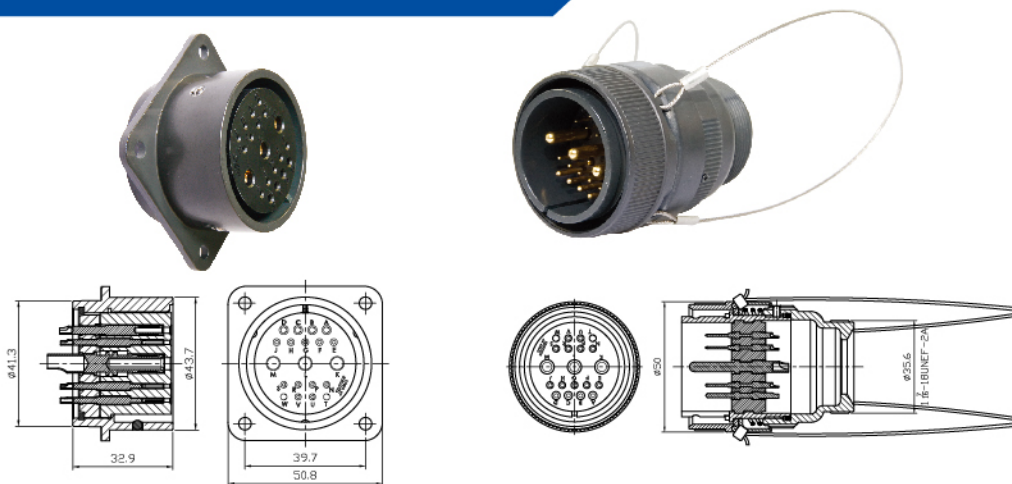

AMS25042B-28D-R • WPS3108F 28-18P-KF009



| No. | ELECTRICAL SPECIFICATIONS | |
|-----|---------------------------|-----------------------|
| 1 | Withstanding voltage | AC:2000V/1MINUTE |
| 2 | Insulation resistance | 5000MΩ min.AT DC 500V |

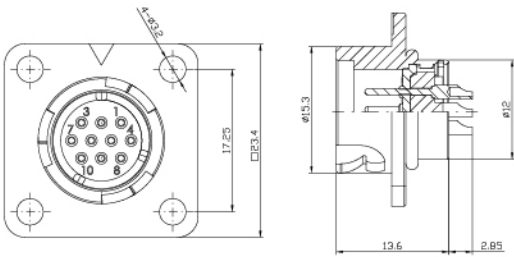

WPM-15-RM-R

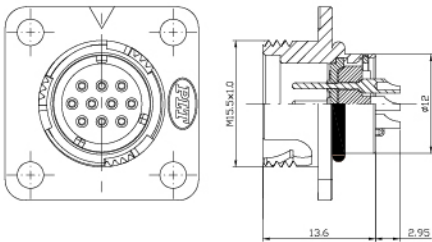

WPM-15-RMB-R



Solder Pin

Crimp Pin

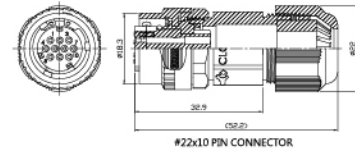

WPM-15-PF-R (Solder Pin)

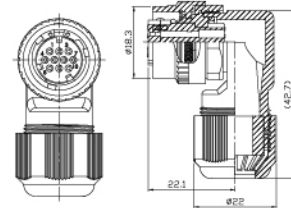

WPM-15-LPF-R (Solder Pin)

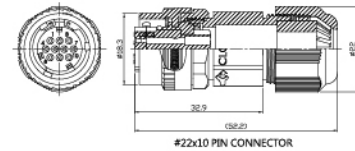

WPM-15-PFG-R (Crimp Pin)

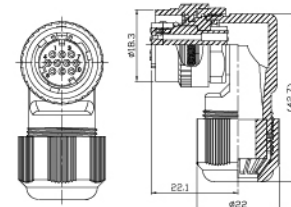

WPM-15-LPFG-R (Crimp Pin)

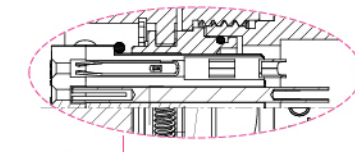

WPM-15-PFB-R (Solder Pin)

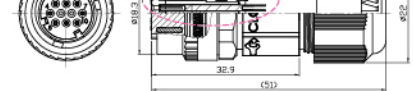

WPM-15-LPFB-R (Solder Pin)

| NO. ELECTRICAL CHARACTERISTICS | | | |
|--------------------------------|--|------|------|
| 1 | Contacts Configuration (◆) | 2 | 10 |
| 2 | Operation limit voltage (AC.V.rms) | 200 | 200 |
| 3 | Withstanding voltage (AC.V.rms) 1 minute | 1500 | 900 |
| 4 | Insulation resistance (MΩ MIN.) at DC 500V | 1000 | 1000 |

WPM-1510-PFA • WPM-1510-AdMA-R



WPM-1510-PFA (Crimp Pin)



WPM-1510-AdMA-R

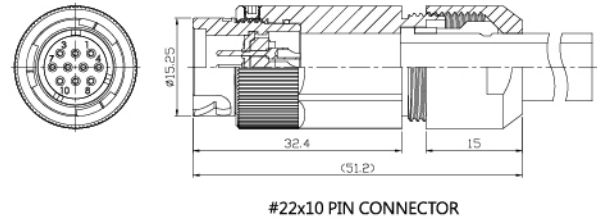
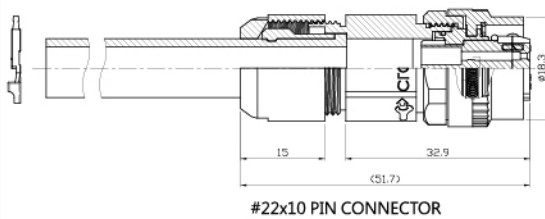

NO. ELECTRICAL CHARACTERISTICS

| | | |
|---|--|------|
| 1 | Operation limit voltage (AC.V.rms) | 200 |
| 2 | Withstanding voltage (AC.V.rms) 1 minute | 900 |
| 3 | Insulation resistance (MΩ MIN.) at DC 500V | 1000 |

OTHERS

WA-1013A-R

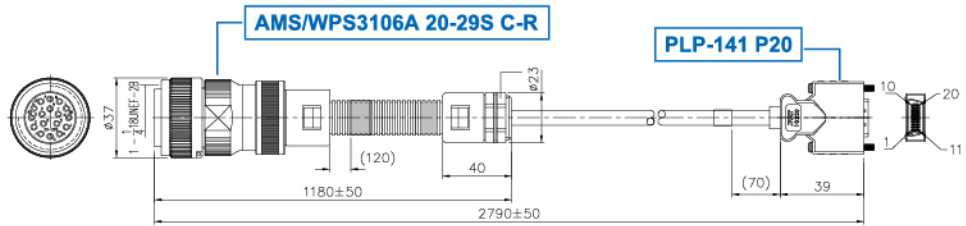

WA-1014A-R

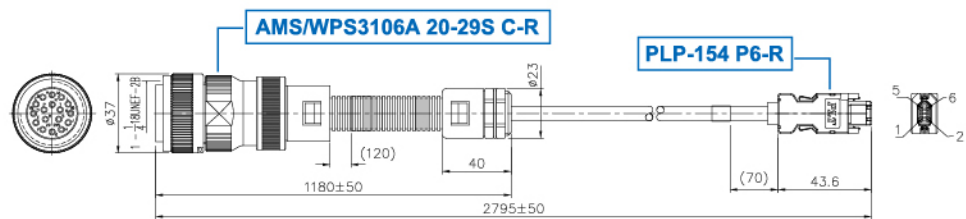

No. ELECTRICAL SPECIFICATIONS

| | | |
|---|-----------------------|-----------------------|
| 1 | Withstanding voltage | AC : 300V / 1 MINUTE |
| 2 | Insulation resistance | 100MΩ min. AT DC 500V |

WA-1015A-R

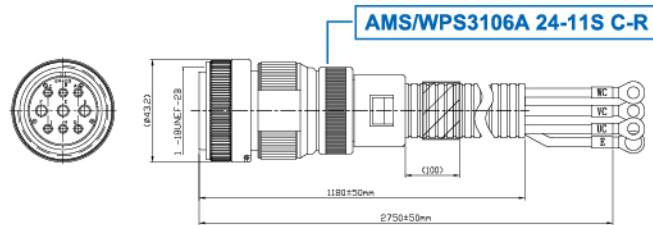

No. ELECTRICAL SPECIFICATIONS

| | | |
|---|-----------------------|-----------------------|
| 1 | Withstanding voltage | AC : 600V / 1 MINUTE |
| 2 | Insulation resistance | 100MΩ min. AT DC 500V |

WA-753A

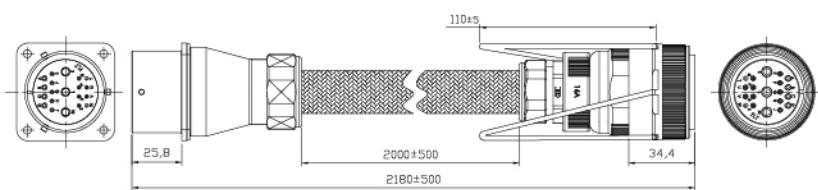

No. ELECTRICAL SPECIFICATIONS

| | | |
|---|-----------------------|-----------------------|
| 1 | Withstanding voltage | AC : 600V / 1 MINUTE |
| 2 | Insulation resistance | 100MΩ min. AT DC 500V |

WPS-2407-SM • WPS-2407-LF

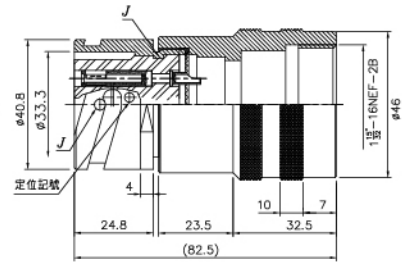
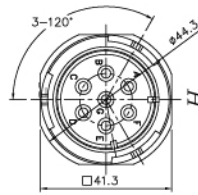
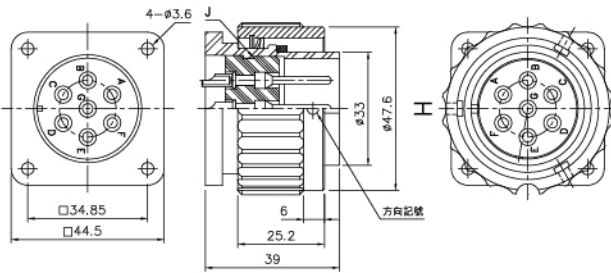

WPS-2407-SF • WPS-2407-LM

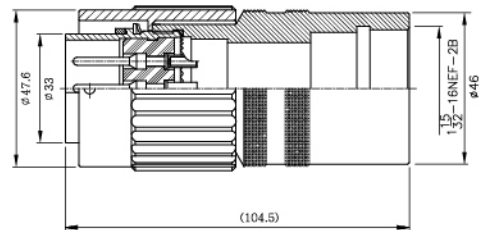
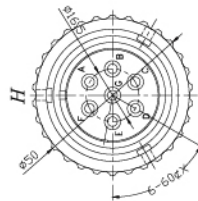
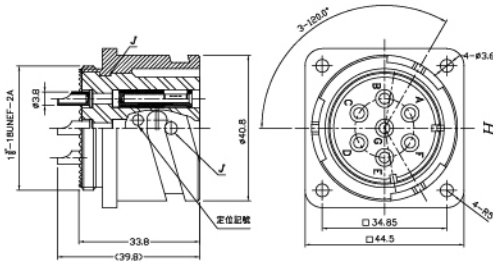

No. ELECTRICAL SPECIFICATIONS

| | | | |
|---|-----------------------|--------------------------|---------------|
| 1 | Operating Voltage | DC: 700V | AC(rms): 500V |
| 2 | Withstanding Voltage | AC: 2000V | 1 minute |
| 3 | Test Current | 22 Amperes | |
| 4 | Insulation Resistance | 5000MΩ min. at DC : 500V | |

IPO / OEM / ODM Series

PLT-6906-R • PLT-6906-P



開發中
DEVELOPING



開發中
DEVELOPING



No. ELECTRICAL CHARACTERISTICS

| | | |
|---|--|---------|
| 1 | Operation Current (per contact) | 500 m A |
| 2 | Operation voltage (AC.V.rms) | 60 |
| 3 | Dielectric strength (V.rms) | 500 |
| 4 | Insulation resistance (MΩ MIN.) at DC 100V | 1000 |
| 5 | Contact resistance (mΩ MIN.) at DC 1A | 50 |

IPO / OEM / ODM Series

WPM-107-ADF-R • WPM-107-PM-R



開發中
DEVELOPING



開發中
DEVELOPING

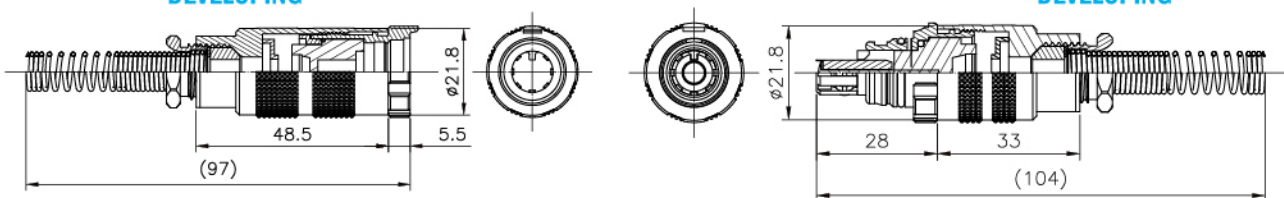

No. ELECTRICAL CHARACTERISTICS

| | | |
|---|-------------------------------------|-------------|
| 1 | Rate Current / voltage | 3A 125V |
| 2 | Operation limit voltage (rms) | 200V AC |
| 3 | Withstanding voltage (rms 1 minute) | 1000V AC |
| 4 | Insulation resistance (at DC 500V) | 1000MΩ MIN. |
| 5 | Contact resistance (at DC 1A) | 5mΩ MAX. |

AMS3204-RM • AMS3204-PF

IPO / OEM / ODM Series

開發中
DEVELOPING

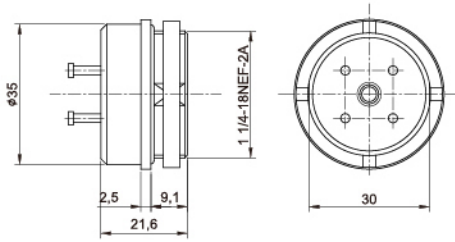

開發中
DEVELOPING

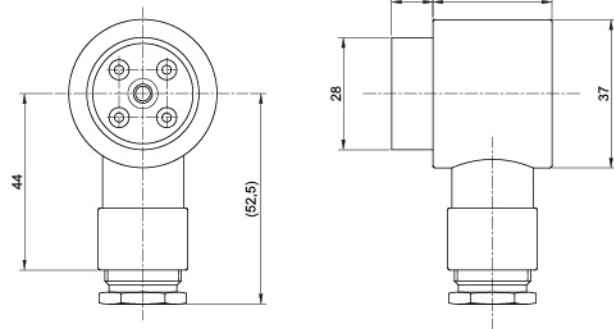

AMS3204-RF • AMS3204-PM

IPO / OEM / ODM Series

開發中
DEVELOPING

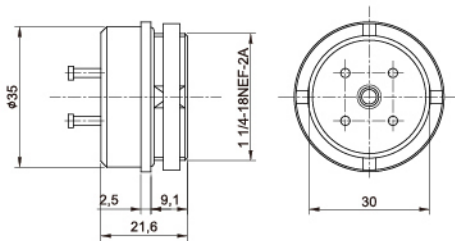

開發中
DEVELOPING

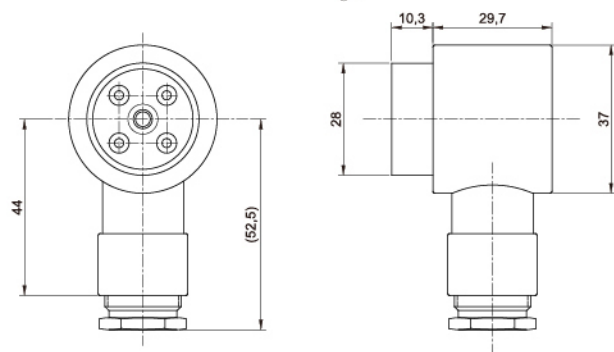

NO. ELECTRICAL CHARACTERISTICS

| | | | |
|---|-------------------------------------|-------------|-------------|
| 1 | Contacts Configuration (◆) | 4 | 18 |
| 2 | Rate Current | 35A | 7.5A |
| 3 | Withstanding voltage (rms 1 minute) | 2000V | 1500V |
| 4 | Insulation resistance (at DC 500V) | 1000MΩ MIN. | 1000MΩ MIN. |
| 5 | Contact resistance (at DC 1A) | 3mΩ MAX. | 3mΩ MAX. |



BUSINESS SCOPE

| The 1st Business Unit

Connector

Military / Waterproof / RF Coaxial / Industrial Series

| The 2nd Business Unit

Various Types of Molds

Customized Mold and Machinery Components Design & Manufacturing

| The 3rd Business Unit

Wire Assembly

| The 4th Business Unit

Wireless Communication

Antenna / Transceiver / Peripheral Accessories

| The 5th Business Unit

Precision Machine Manufacturing

CNC Turning and Milling Compound Lathe / Precision Arbor Press and Mechanical Press Manufacturing

| The 6th Business Unit

Medical Facilities for Senior Health Care

Wireless Remote Control Patient Care System / Medical Care On-Call System

| The 7th Business Unit

Channels of Distribution for Products Solution

100% MADE IN TAIWAN



- A S 9100D 航太國防工業品質管理系統認證通過
Quality Management Systems-Requirements For Aviation, Space, and Defense Organizations
- IATF 16949 全球汽車產業品質管理系統認證通過
Certified In Global Automobile Industry
- ISO 9001 國際品質管理系統認證通過
Environmental Management Systems
- ISO 14001 國際環境管理系統認證通過
Quality Management Systems

Agent / 代理商



總公司 / 總廠 : 24264 新北市新莊區民安西路405號 E-mail: apexmail@plt.com.tw
Headquarters No. 405, Min-an W. Rd., Sinjhuang District, New Taipei City 24264, Taiwan
TEL : +886-2-2206-8899 FAX : +886-2-2208-0559

台中 / 大雅廠 : 42844 台中市大雅區民生路3段191巷4號、6號、8號 (面積8,888 m²)
Taichung Plant No. 8, Lane 191, Section 3, Minsheng Rd., Daya District, Taichung City 42844, Taiwan
TEL : +886-4-2560-7272 FAX : +886-4-2565-2228

日本分公司 : 株式会社 PLT JAPAN Technology R&D / Import & Export
Japan 〒151-0053 東京都渋谷区代々木3丁目28番-1
Branch Office 28-1, Yoyogi 3-Chome, Shibuya-ku, Tokyo, Japan
TEL : +81-3-6276-8845 FAX : +81-3-6276-6645
Mobile : +81-80-4166-2688

